



Monteringsanvisning

Glasrücke Aluminium

Innehållsförteckning

Inför montering	2
Verktyg	2
Komponenter	3-4
Ritning	4-5
Montering kvadratiska stolpar	6-7
Montering kvadratiska stolpar	8-9
Skötselråd	10

Inför montering

- Läs hela monteringsanvisningen innan du påbörjar monteringen! Följs inte anvisningen kommer kanske produkten inte fungera optimalt och garantin kommer inte att gälla.
- Willab garden förbehåller sig rätten till ändringar i material, konstruktion och design.
- Kolla igenom din leverans så att denna är komplett och så att ingenting har blivit skadat under transporten.
- Skruv för infästning i grund ingår ej. Rådgör med fackman för korrekt infästning i ditt underlag.
- För att montera ett räcke då fallhöjden är över 3 m krävs att räcket är 1,1m högt. Vilket är höjden vid val av överliggare.
- Vidare information gällande montage på höjd över 3 m från mark hänvisas till Boverkets Byggregler, avsnitt 8:352 Skydd mot fall genom glas samt 8:2321 Räckena.

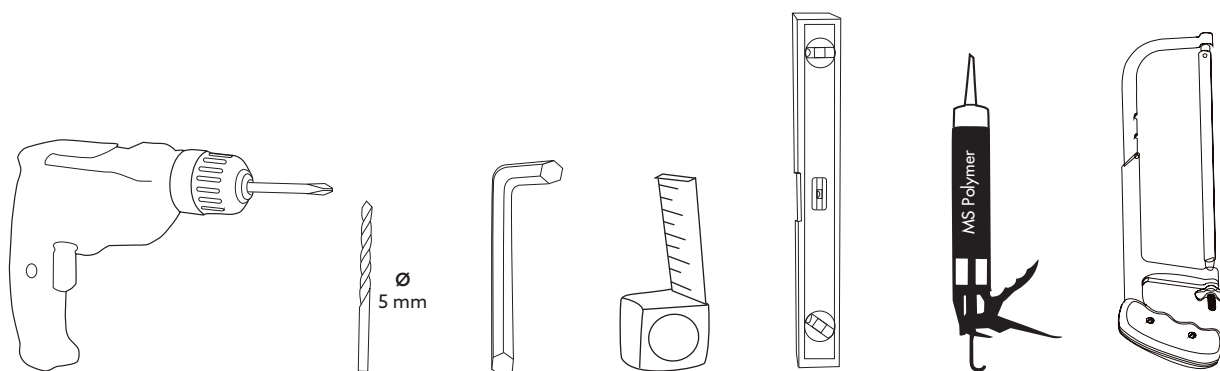

Komponenter

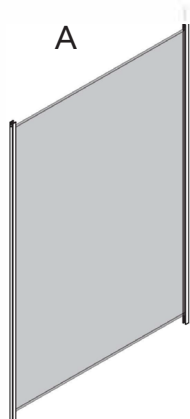

8 mm Laminerat Glas
1000 x 905 mm
741070 / 741040
741079 / 741049

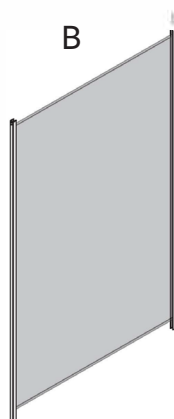

8 mm Laminerat Glas
900 x 905 mm
741970 / 741940
741979 / 741949

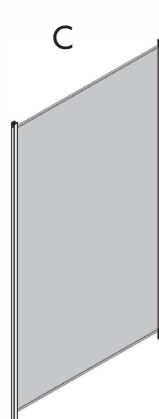

8 mm Laminerat Glas
800 x 905 mm
741870 / 741840
741879 / 741849

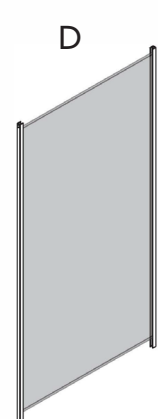

8 mm Laminerat Glas
700 x 905 mm
741770 / 741740
741779 / 741749

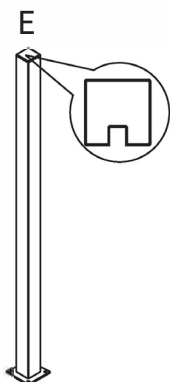

Kantstolpe
50 x 50 x 990 mm
742071 / 742041

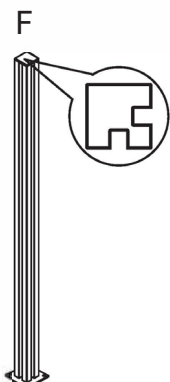

Hörnstolpe
50 x 50 x 990 mm
742073 / 742043

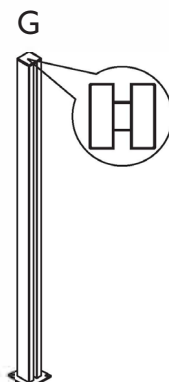

Mittstolpe
50 x 50 x 990 mm
742072 / 742042

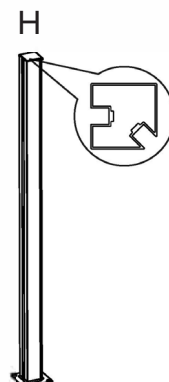

45 Graders Stolpe
50 x 50 x 990 mm
742075 / 742045

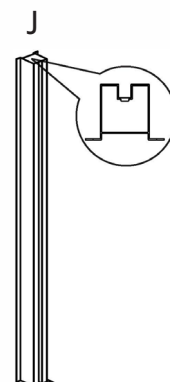

Stolpe För Väganslutning
50 x 80 x 990 mm
742074 / 742044

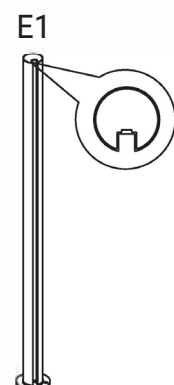

Kantstolpe
50 x 50 x 990 mm
744071 / 744041

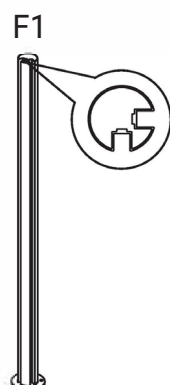

Hörnstolpe
50 x 50 x 990 mm
744073 / 744043

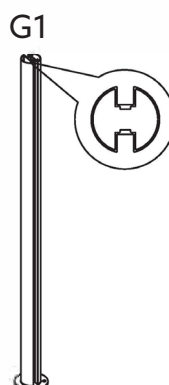

Mittstolpe
50 x 50 x 990 mm
744072 / 744042

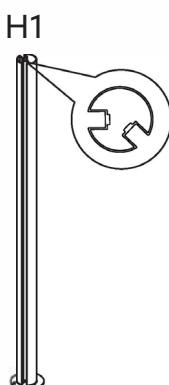

45 Graders Stolpe
50 x 50 x 990 mm
744075 / 744045

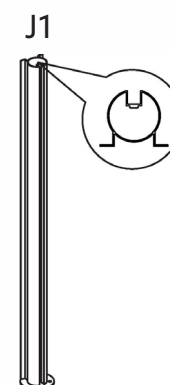

Stolpe För Väganslutning
50 x 80 x 990 mm
744074 / 744044

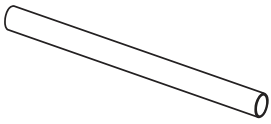
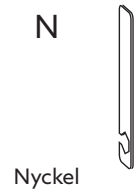
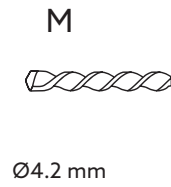
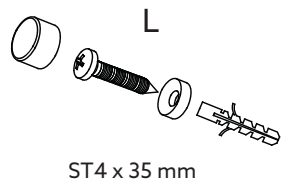
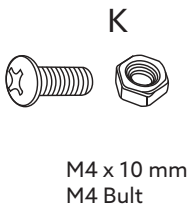

Räcke Längd 101 cm
743071 / 743041 / 743081

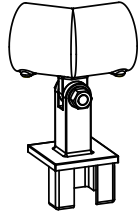

Aluminiumräckeshållare
45 grader
743077 / 743047

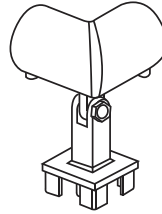

Aluminiumräckeshållare
Hörn
743076 / 743046

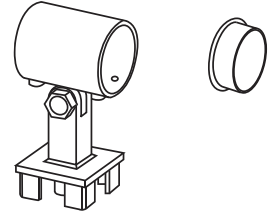

Aluminiumräckeshållare
Mitt med täcklock
743075 / 743045

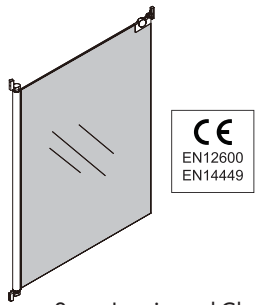

8mm Laminerad Glasdörr
Med lås
900 x 905 mm
741140 / 741170
741149 / 741179

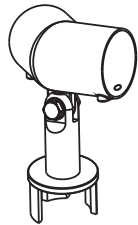

Aluminiumräckeshållare
45 grader
745077 / 745047

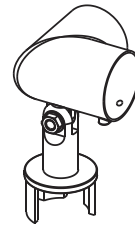

Aluminiumräckeshållare
Hörn
745076 / 745046

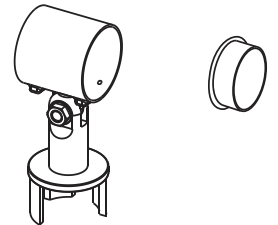

Aluminiumräckeshållare
Mitt med täcklock
745075 / 745045

- Glasräckets överliggare ska kapas cc -10mm från stolpen.

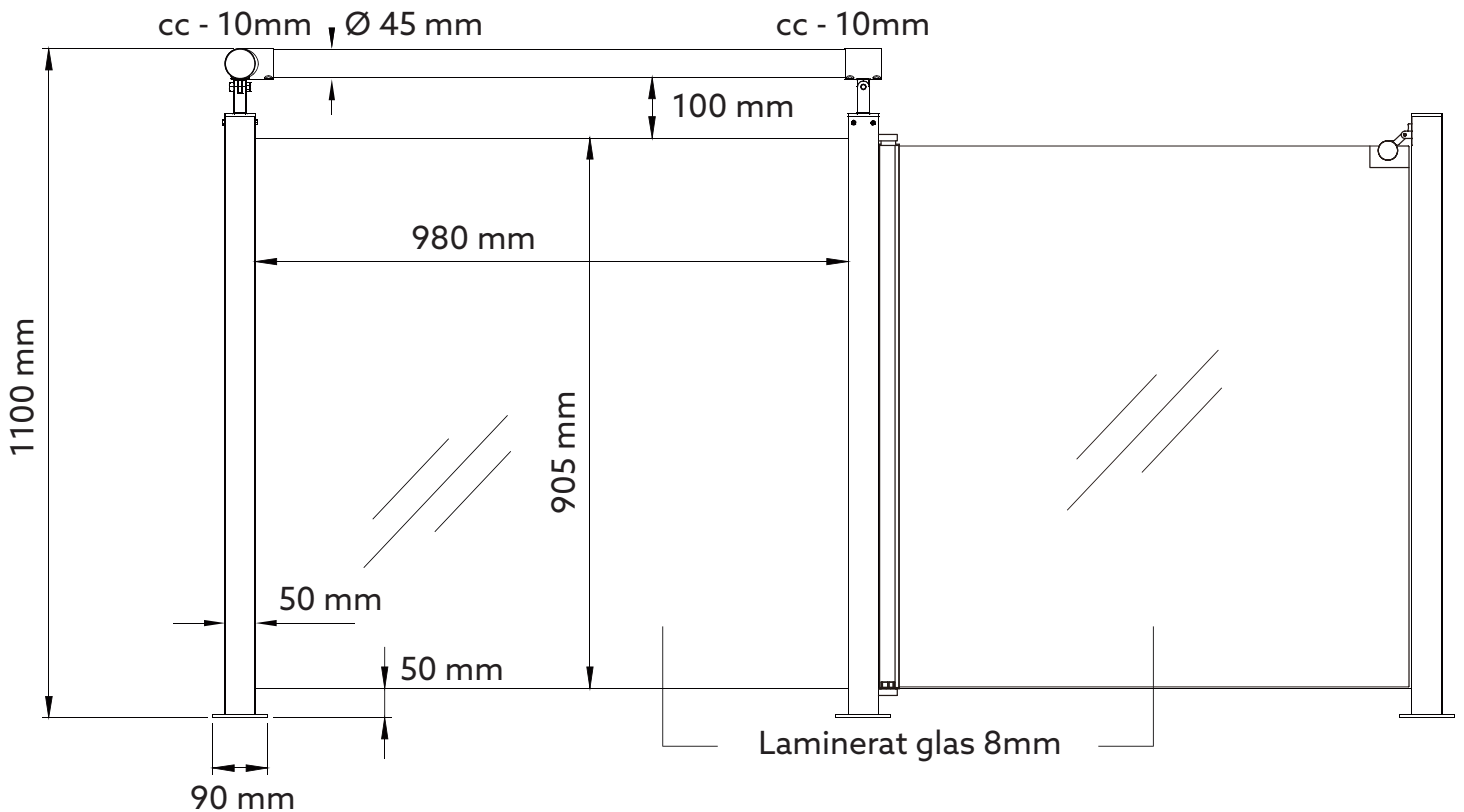

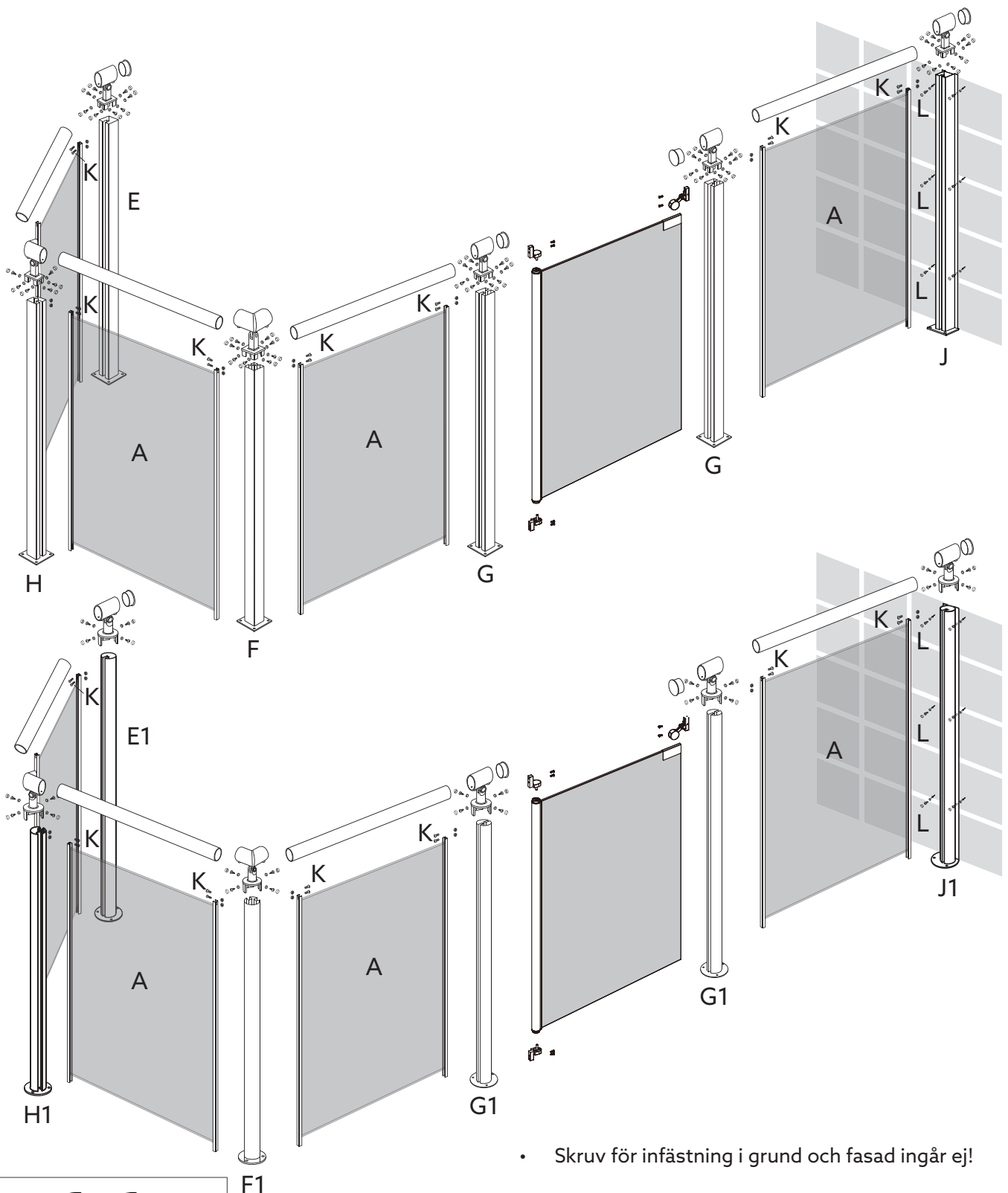

- Skruv för infästning i grund och fasad ingår ej!

CE	
<small>GUANGZHOU HUAFENG SAFETY GLASS CO., LTD NO. 68, BIG BRIDGE STREET, XILANG, LIWAN DISTRICT, GUANGZHOU P.R. CHINA</small>	
<small>14</small>	
<small>EN 14449 Laminated glass, intended to be used in buildings and shower enclosure</small>	
Characteristics	
Resistance to fire	: NPD
Reaction to fire	: A1
External fire performance	: NPD
Bullet resistance	: NPD
Explosion resistance	: NPD
Burglar resistance	: NPD
Pendulum body impact resistance	: EN 12600 1(B)1
Resistance against sudden temperature changes and temperature differentials	: NPD
Wind, snow, permanent and imposed load resistance	: NPD
Direct airborne sound insulation	: NPD
Thermal properties	: NPD
Radiation properties^[c]1]	: NPD
- Light transmission and reflection	
- Solar energy characteristics	
Declaration of Performance No.	: 001-CPR-201406



Säkerhetsvarning:

- Glasracket är endast för utomhusbruk.
- Glasracket skall alltid fästas ordentligt i marken/golvet.
- Glasracket är designat för att användas på marknivå. Det skall inte och får inte användas där marken inte är jämn.

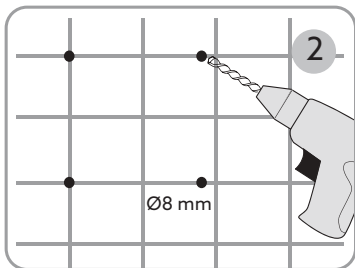
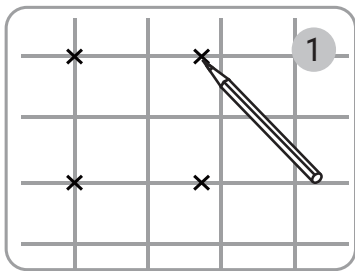

- Skruv för infästning grund och fasad ingår ej!

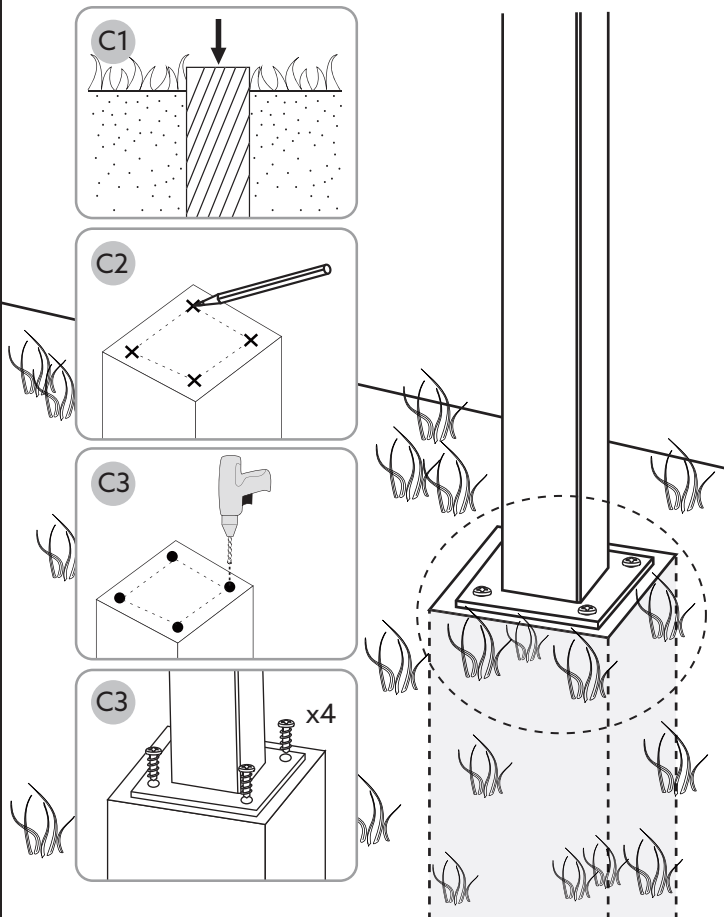
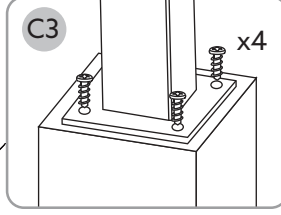
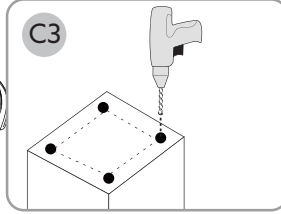
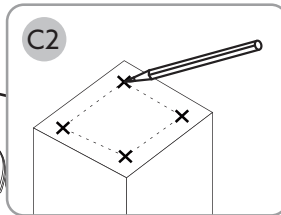
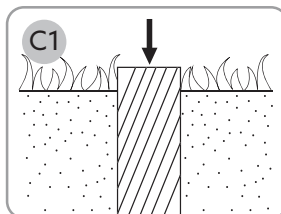
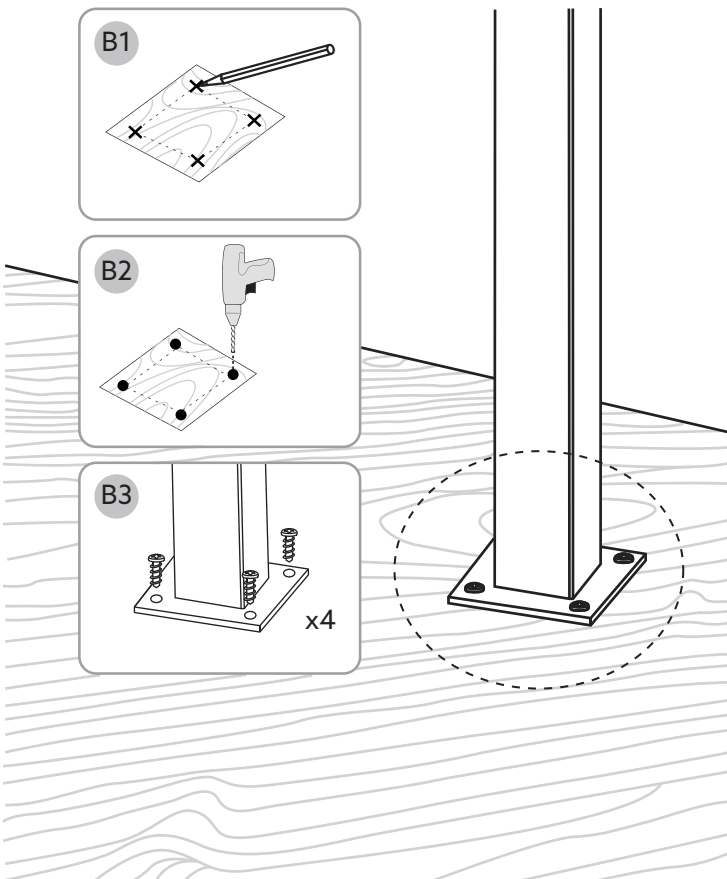
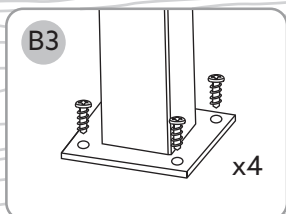
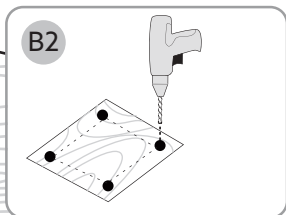
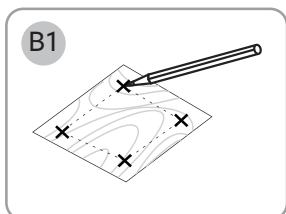
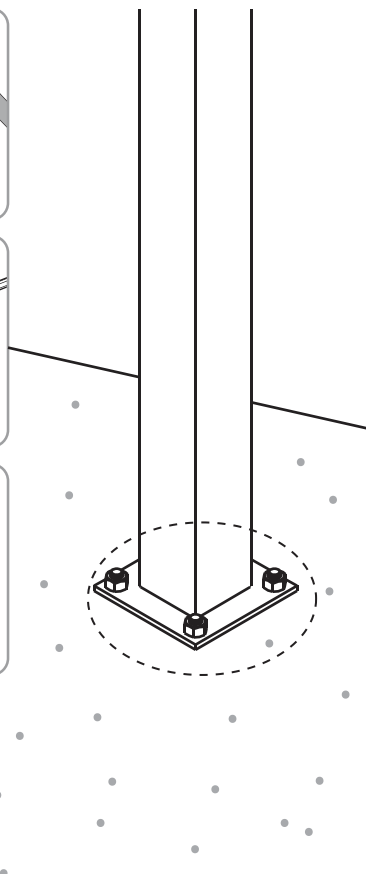
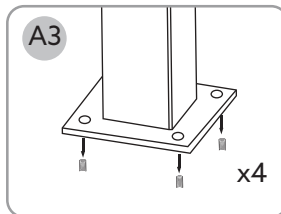
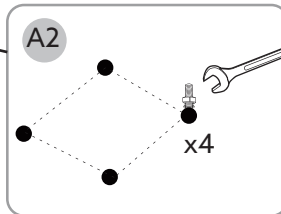
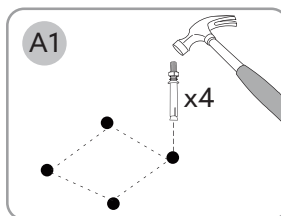

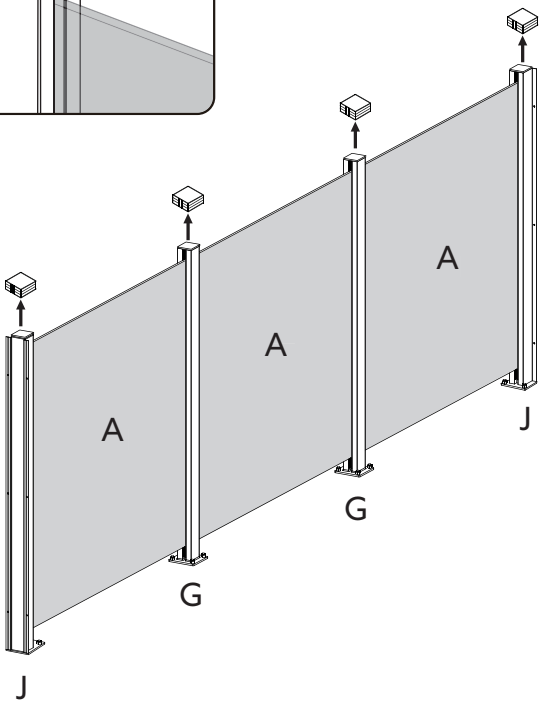
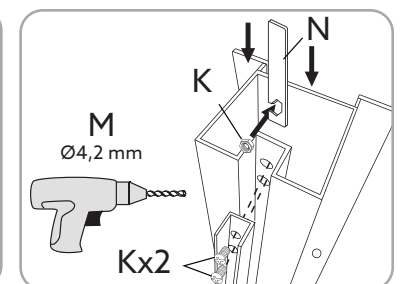
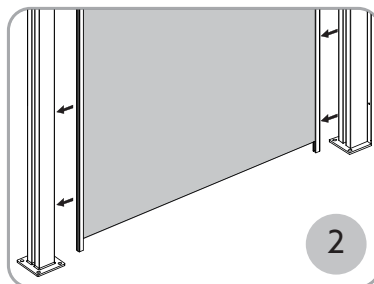
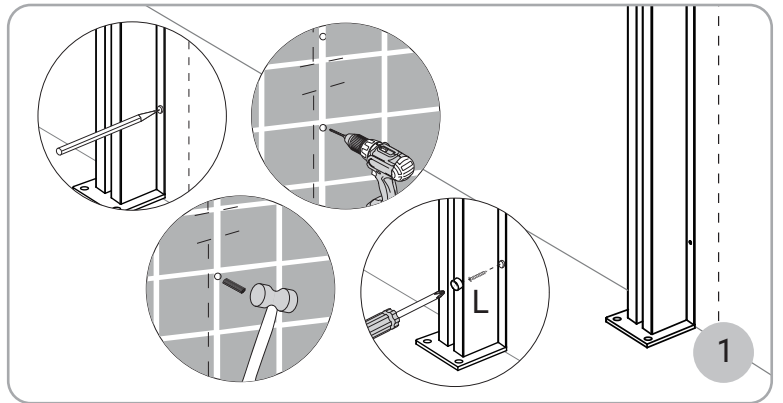
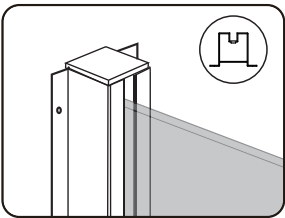
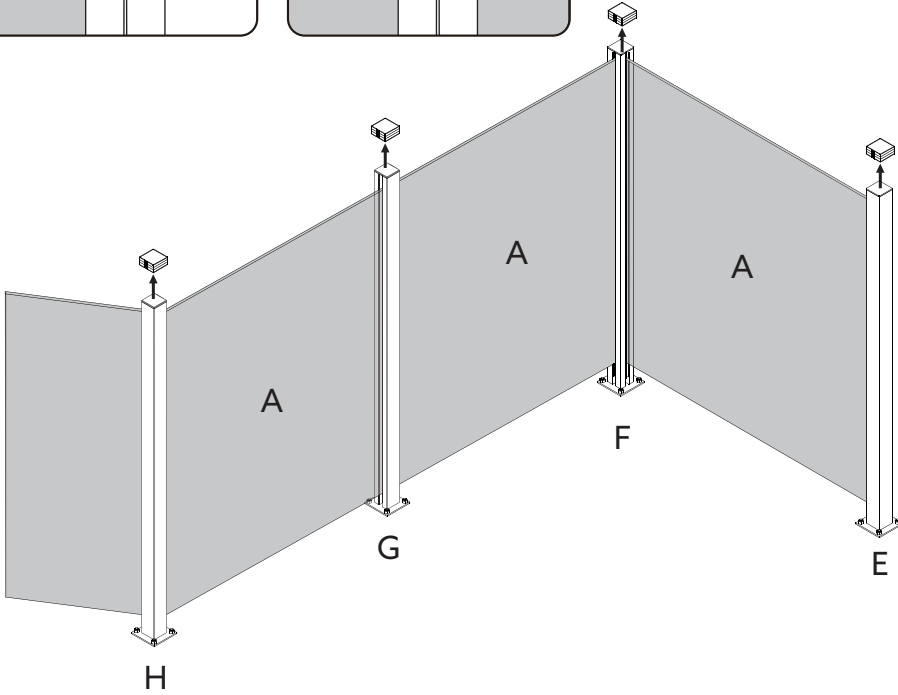
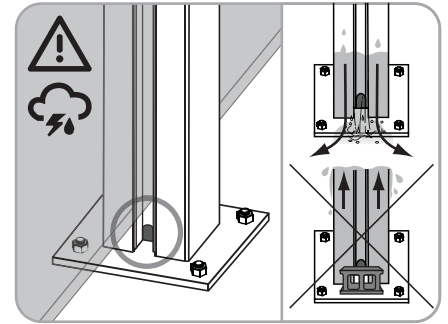
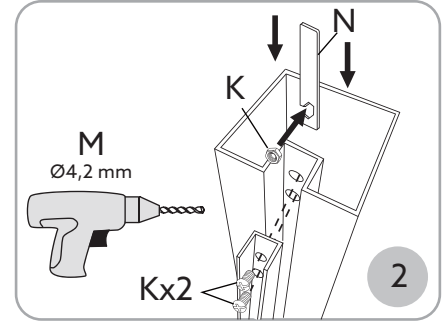
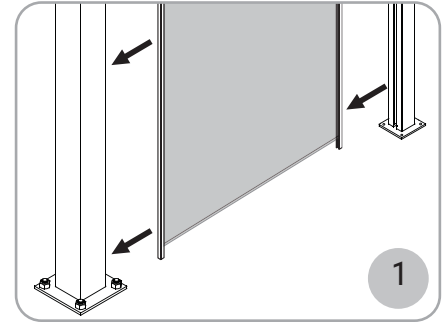
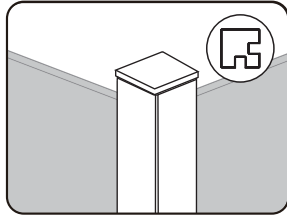
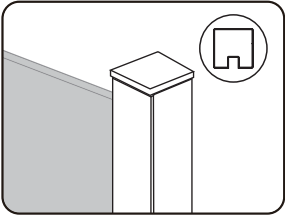
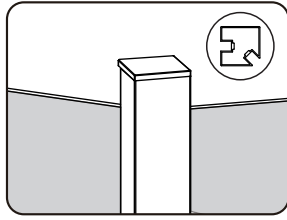
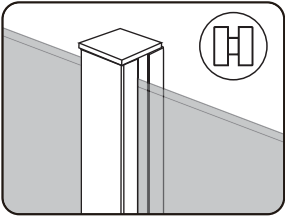

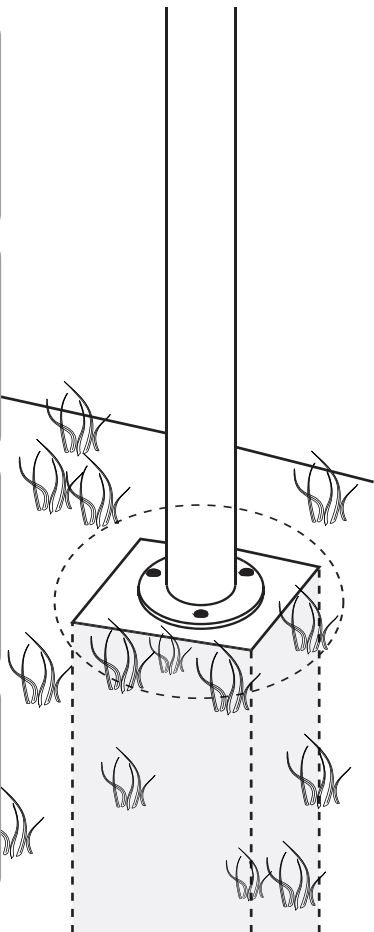
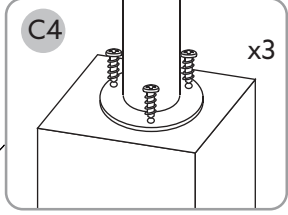
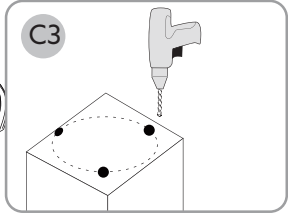
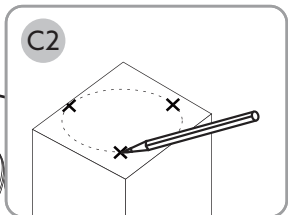
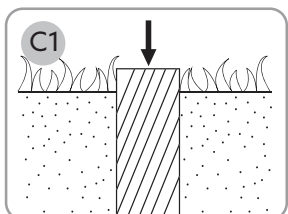
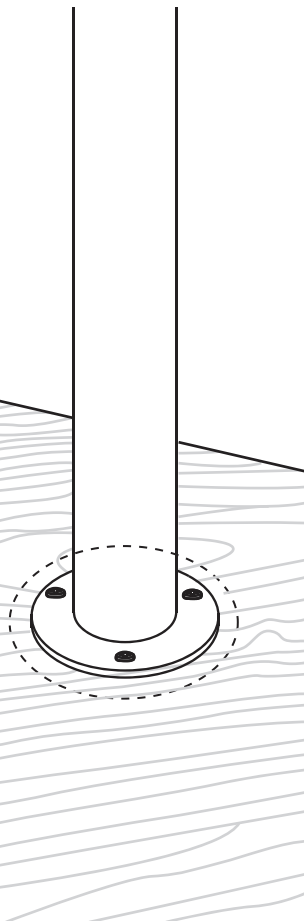
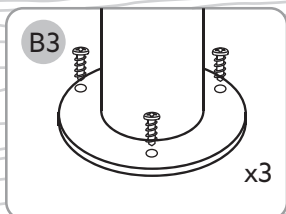
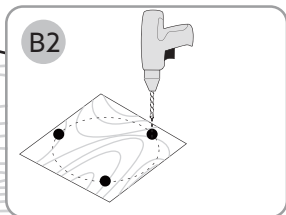
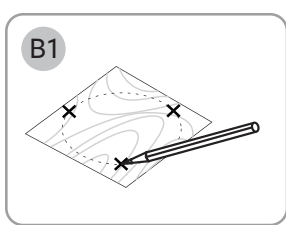
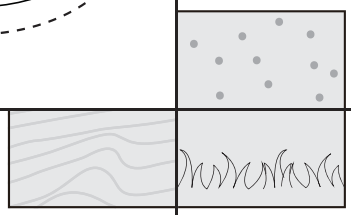
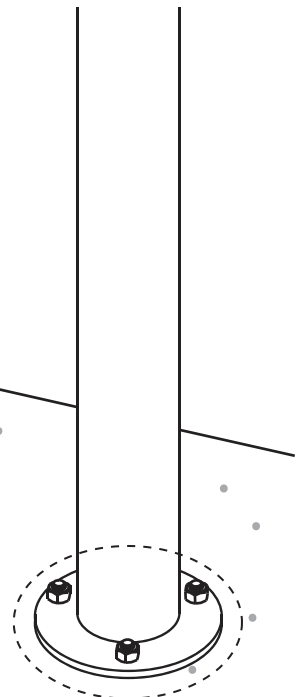
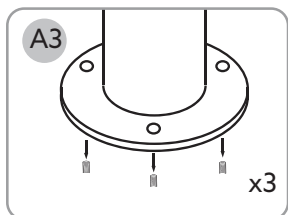
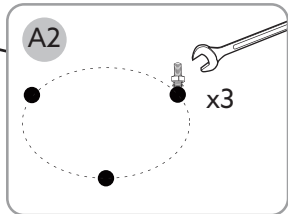
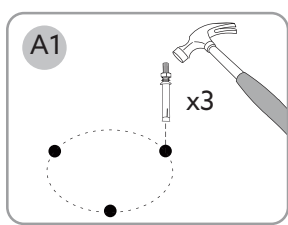
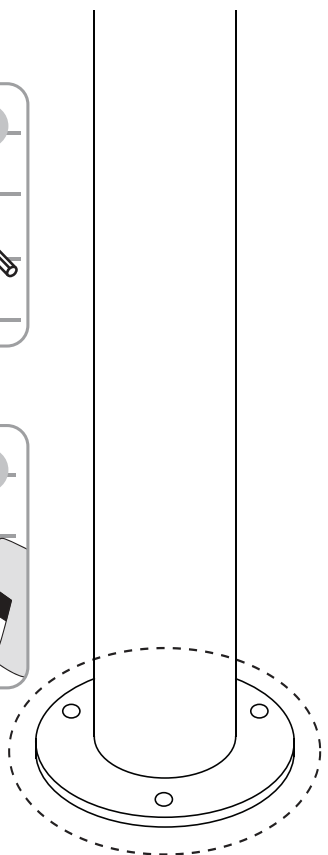
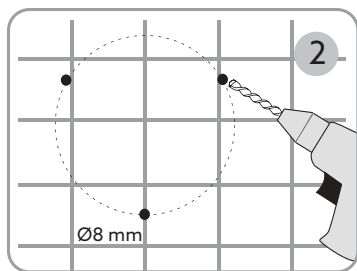
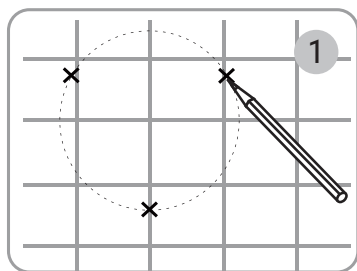

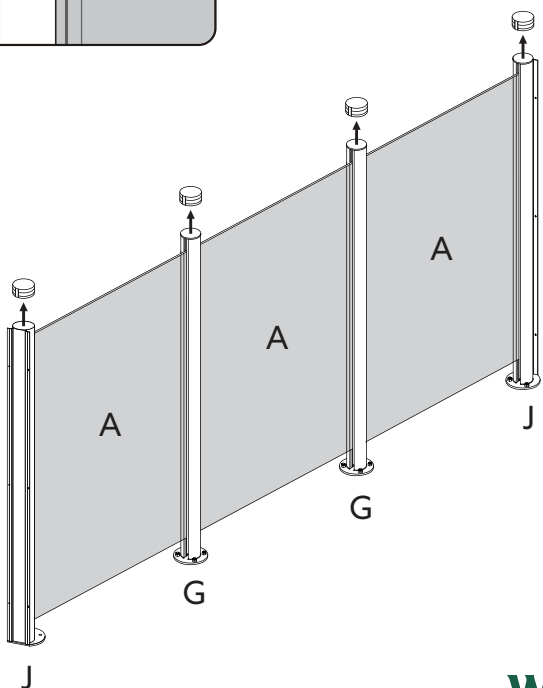
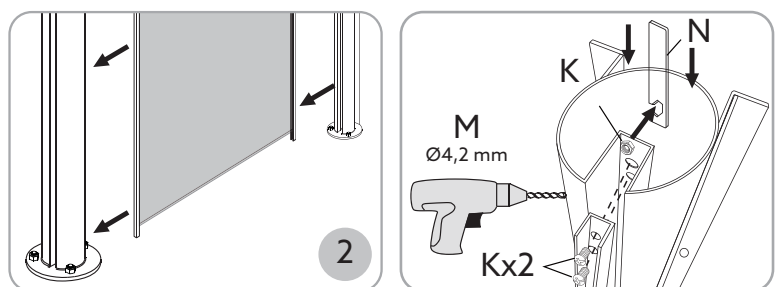
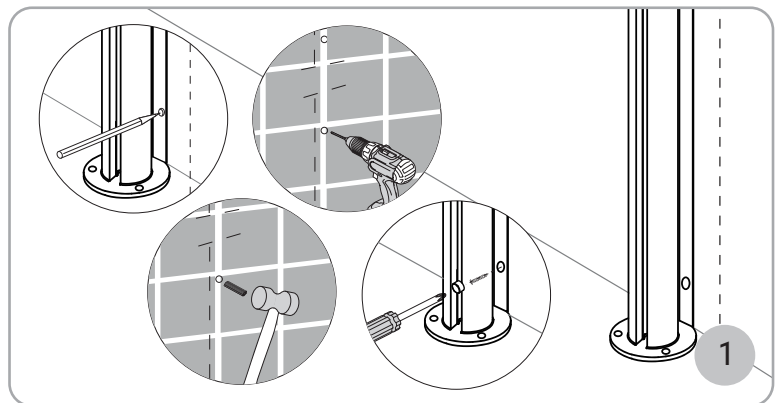
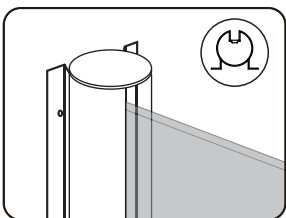
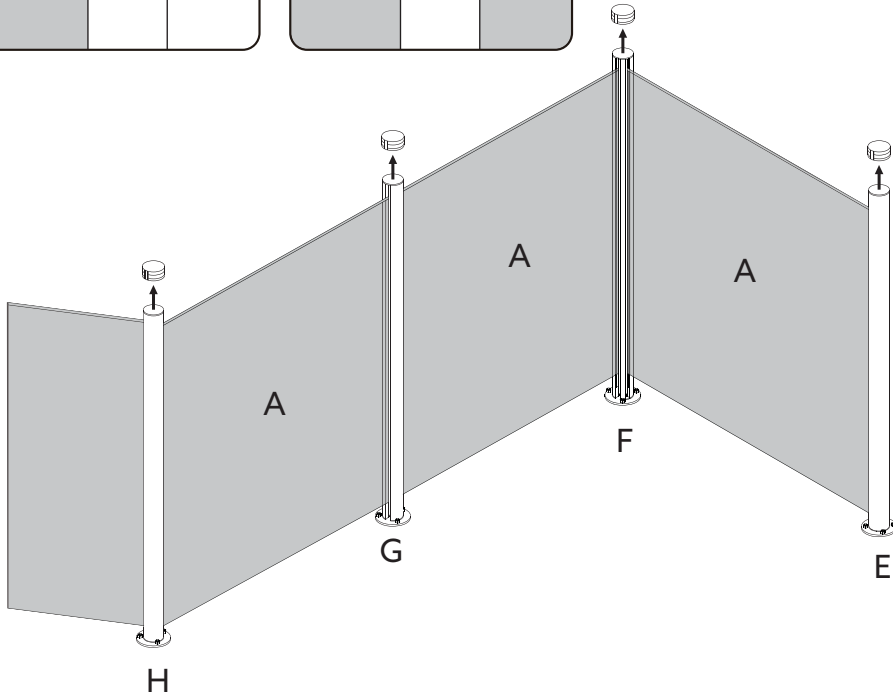
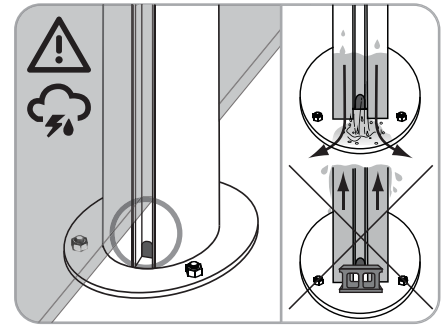
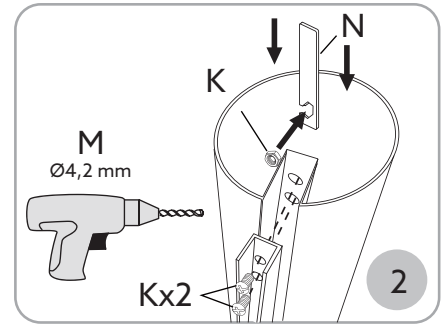
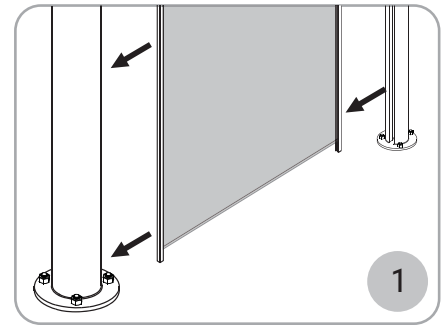
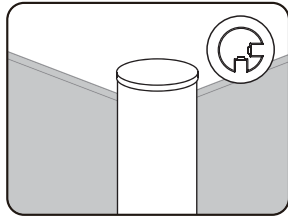
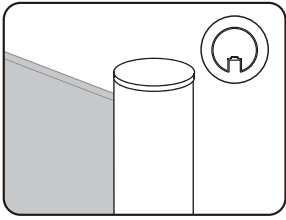
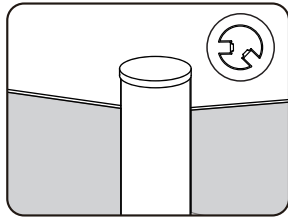
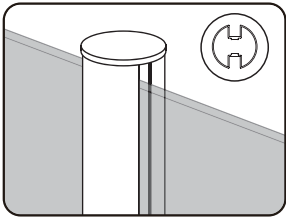

Skötselråd

Regelbunden och rätt utförd rengöring med passande rengöringsmedel rekommenderas för att förlänga glasräckets livslängd.

Aluminiumprofiler

- Använd mild såpa, handdiskmedel eller bara vanligt vatten räcker för att rengöra profiler.

Glas

- Glas skall rengöras som vanligt glas.
- Använd vanliga fönstertvättmedel, rikligt med vatten och mjuk, luddfri trasa eller gummiskrapa.
- Rödspit eller aceton löser vissa föroreningar. Sidol, Häxan, Brillo eller annat skonsamt putsmedel kan polera bort andra föroreningar. Putsmedlet tvättas bort med rödspit. Tvätta sedan glaset på vanligt sätt.
- Använd inte skrapa, metallföremål eller stålull för att skrapa bort hårt sittande smuts.

