

Green Room[®]

BY WILLAB GARDEN

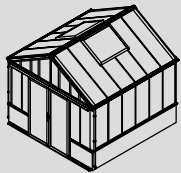

3721

321 × 321 × 306
cm

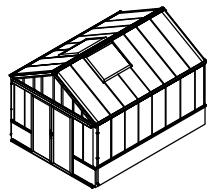

3722

421 × 321 × 306
cm

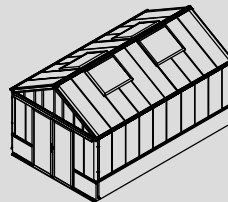

3723

521 × 321 × 306
cm

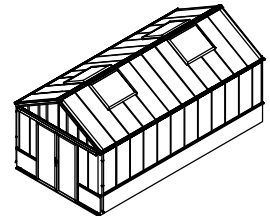

3724

621 × 321 × 306
cm

Product size (L×W×H):

Storlek (L×B×H):

Størrelse (L×B×H):

Størrelse (L×B×H):

Koko (P×L×K):









Please read carefully before assembling.
Two people are needed.













Läs noggrant innan montering.
Det krävs två personer för montering.













































Læs venligst omhyggeligt, før montering.
Der kræves to personer til montering.















Les monteringsanvisningen nøye innen montering.
Det kreves to personer for montering.

Lue ohjeet huolellisesti läpi ennen asentamista.
Asentamiseen tarvitaan kaksi henkilöä.

Part	3721			3722			3723			3724			QTY.	Code	Page
	NO.	Length(MM)	NO.	Length(MM)	NO.	Length(MM)	NO.	Length(MM)	NO.	Length(MM)					
	41A-Y11-3	3238	41A-Y11-4	4239	41A-Y11-5	5240	41A-Y11-6	6241	41A-Y11-6A	5964	2	A001	P2		
	41A-Y11-3A	2960	41A-Y11-4A	3962	41A-Y11-5A	4963	41A-Y11-6A	5964	41X-Y62-6	6230	2	A002	P2		
	41X-Y62-3	3227	41X-Y62-4	4228	41X-Y62-5	5229	41X-Y62-6	6230	41X-Y63-6	6209	1	A004	P6		
	41X-Y63-3	3206	41X-Y63-4	4207	41X-Y63-5	5208	41X-Y63-6	6209	41X-Y62-6BR	6230	1	A005	P9		
	41X-Y62-3BR	3227	41X-Y62-4BR	4228	41X-Y62-5BL	5229	41X-Y62-6BL	6230	41X-Y62-6BL	6230	1	A006	P9		
	41X-Y62-3BL	3227	41X-Y62-4BL	4228	41X-Y15-4	4239	41X-Y15-6	6241	41X-Y15-6	6241	2	A007	P12		
	41X-Y15-3	3238	41X-Y15-4	4239	41X-Y63-4A	4207	41X-Y63-6A	6209	41X-Y63-6A	6209	2	A008	P18		
	41X-Y63-3A	3206	41X-Y63-4A	4207	41X-Y62-4A	4228	41X-Y62-6A	6230	41X-Y62-6A	6230	2	A009	P27		
	41X-Y62-3A	3227	41X-Y62-4A	4228											

























Part	NO.	QTY.			Length(MM)	Page	Part	NO.	QTY.			Length(MM)	Page
		3721	3722	3723					3724	3721	3722		
	41A-Y30	9	11	13	15	P5		41X-Y06	4	6	8	10	P17
	41X-Y33R	2	2	4	4	P8		41X-Y07	2	2	4	4	P17
	41X-Y33L	2	2	4	4	P8		41X-Y80	2	2	4	4	P25
	41X-Y33	0	2	0	2	P8		41X-Y81	4	4	8	8	P25
	41X-Y35	2	3	4	5	P10		41X-Y84	4	4	8	8	P25
	41A-Y01	9	11	13	15	P12		41X-Y83	4	4	8	8	P25

Part	NO.	QTY.	Length(MM)	Page	Part	NO.	QTY.	Length(MM)	Page
	41A-Y12	1	3239	P2		41A-Y97-B	2	1918	P21
	41A-Y13R	1	894	P2		41A-Y97-A	2	1918	P21
	41A-Y13L	1	894	P2		41A-Y97-R	1	1951	P21
	40A-Y12-A	1	3022	P2		41A-Y97-L	1	1951	P21
	41A-Y13R-A	1	785	P2		41A-Y94	1	1946	P21
	41A-Y13L-A	1	785	P2		41A-Y98-R	1	2000	P22
	41A-Y20	4	1336	P3		41A-Y98-L	1	2000	P22
	41X-Y61	1	3023	P4		41A-Y99	1	1410	P22
	41X-Y60	1	3023	P4		41A-Y100	1	1410	P22
	41X-Y32	2	857	P6		41A-Y64	1	3016	P23
	41X-Y21	2	1715	P7		41A-Y17	1	3120	P23
	41X-Y22	2	1715	P7		41A-Y98A-R	1	1923	P23
	41X-Y31R	2	412	P7		41A-Y98A-L	1	1923	P23
	41X-Y31L	2	412	P7		41X-Y61-A	1	3023	P27
	41A-Y14L	1	894	P12		41X-Y60-A	1	3023	P27
	41A-Y14R	1	894	P12					
	41X-Y14	1	3239	P12					
	41A-Y02	8	1335	P12					
	41X-Y03	2	857	P14~15					
	41X-Y04R	2	412	P14~15					
	41X-Y04L	2	412	P14~15					
	41X-Y05R	2	1712	P14~15					
	41X-Y05L	2	1712	P14~15					
	41X-Y06B	4	1782	P17					
	41A-Y90	2	1958	P19					
	41A-Y91R	1	1958	P19					
	41X-Y92R	1	776	P19					
	41X-Y93	2	776	P19					
	41A-Y91L	1	1958	P19					
	41X-Y92L	1	776	P19					
				1b/30					













Part	NO.	QTY.				Length(MM)	Page
		3721	3722	3723	3724		
	M8-20	60	60	68	68	PCS	P3~8
	Si8-16	100	120	140	160	PCS	P3~10
	7B33-020	105	125	145	165	PCS	P3~23
	7C33-001	16	16	24	24	PCS	P3~8
	7C28-004	21	25	29	33	PCS	P9~23
	Z4.2-13	26	30	34	38	PCS	P9~21
	J12	90	102	120	132	PCS	P11~25
	7B33-019	4	6	8	10	PCS	P17
	Z4.2-50	13	15	17	19	46	P18~23
	W04	24	24	32	32	PCS	P19~25
	W02	8	8	16	16	PCS	P25
	T07	4	4	8	8	PCS	P26
	7C26-007N	20M	34M	38M	42M		P13~16
	7C26-022	8.5M	8.5M	17M	17M		P25

Part	NO.	QTY.	Length(MM)	Page	Part	NO.	QTY.	Length(MM)	Page
	7B33-001	4	PCS	P2		7C33-S02	2	PCS	P28
	W03	12	30	P2~19		7C33-S03	4	PCS	P29
	PS8-80	20	PCS	P2~22		Z4.8-25	4	PCS	P29
	J09	8	PCS	P2		7B33-015L	2	PCS	P30
	7B33-002	4	PCS	P3		7B33-015R	2	PCS	P30
	7B33-003	4	PCS	P3		7C33-004	4	PCS	P30
	J08	1	PCS	P3		7B33-016	2	PCS	P30
	7B33-008	4	PCS	P4		7C33-005	2	PCS	P30
	7B33-017	2	PCS	P17					
	7B33-018	2	PCS	P17		NSST120	2.0M		P21
	T04	2	PCS	P21		7C33-S01	2	1980	P29
	Z4.2-38	4	PCS	P21					
	Z3.5-25	8	PCS	P21~24		MCJT002	13M		P20
	M8-35	2	PCS	P22					
	Si8-35	2	PCS	P22		TOOLS	1	PCS	
	Si6-35	4	PCS	P22			1	PCS	
	J05	12	PCS	P22			1	PCS	
	Si6-16	8	PCS	P22			1	PCS	
	Si8-25	3	PCS	P23			1	PCS	
	7C26-031	2	PCS	P23			1	PCS	
	T01	1	PCS	P24					
	T01A	1	PCS	P24					
	J02	2	PCS	P24					
	7B33-049	1	PCS	P24					
	7B33-050	1	PCS	P24					
	7B33-051	1	PCS	P24					
	7B33-052	1	PCS	P24					
	M4-40	2	PCS	P24					
	Mi4-17	2	PCS	P24					
	Za4.2-13	44	PCS	P24~30					
				1d/30					

















SH2GA1-BSC-2

Part	NO.	QTY.	Length(MM)	Page	Part	NO.	QTY.	Length(MM)	Page
	41A-Y30	6	1335	P7		7B33-005	20	PCS	P2~8
	41X-Y31A-L	2	196	P7		Ma8-20	56	PCS	P2~8
	41X-Y31A-R	2	196	P7		M8	56	PCS	P2~8
	51X-Y31L	2	629	P7		Si8-16	40	PCS	P3~10
	51X-Y31R	2	629	P7		7B33-020	40	PCS	P3~10
	41X-Y01	6	1335	P12		7B33-013R	4	PCS	P7
	41X-Y04A-R	2	196	P14~15		7B33-013L	4	PCS	P7
	41X-Y04A-L	2	196	P14~15		M8-20	16	PCS	P7
	51X-Y04R	2	629	P14~15		J12	42	PCS	P11~15
	51X-Y04L	2	629	P14~15					
						L13	4	1344	P4
	TOOL-010	1	330			L14	4	1380	P4
	TOOL-011	1	455			L15	4	1761	P8
	TOOL-012	1	393.6						

SH2GA1-EXTN-2

























Part	NO.	QTY.	Length(MM)	Page	Part	NO.	QTY.	Length(MM)	Page
	41A-Y30	2	1335	P7		7B33-005	8	PCS	P2~8
	41A-Y33-B	2	1715	P8		Ma8-20	16	PCS	P2~8
	41X-Y01	2	1335	P12		M8	16	PCS	P2~8
	41X-Y102	4	480	P17		Si8-16	16	PCS	P3~10
	41X-Y06	2	1782	P17		7B33-020	16	PCS	P3~10
						J12	12	PCS	P17
						7B33-019	2	PCS	P17











SH2GA1-EXTW-2

Part	NO.	QTY.	Length(MM)	Page	Part	NO.	QTY.	Length(MM)	Page
	41A-Y30	2	1335	P7		7B33-005	6	PCS	P2~8
	41A-Y33-C	2	833	P8		Ma8-20	12	PCS	P2~8
	41A-Y34A	2	951	P8		M8	12	PCS	P2~8
	41X-Y01	2	1335	P12		Si8-16	12	PCS	P3~10
	41X-Y06A	2	890	P17		7B33-020	12	PCS	P3~10
	41X-Y102	4	480	P17		M8-20	4	PCS	P8
	41X-Y82-A	2	1087	P25		7C33-001	4	PCS	P8
						J12	12	PCS	P17
						7B33-019	2	PCS	P17

NO.	QTY.			
	3721	3722	3723	3724
SH2GA1-BSC-2	1	1	1	1
SH2GA1-EXTN-2	2	3	3	4
SH2GA1-EXTW-2	1	1	2	2

Spare Part Bag For Green Room Season Wall

Part	NO.	QTY.	Length(MM)	Page	Part	NO.	QTY.	Length(MM)	Page
	J09	2	PCS	P2		M8-35	2	PCS	P22
	M8-20	6	PCS	P3~8		Si8-35	2	PCS	P22
	Si8-16	10	PCS	P3~10		Si6-35	2	PCS	P22
	7B33-020	10	PCS	P3~10		J05	2	PCS	P22
	7C33-001	4	PCS	P3~8		Si6-16	2	PCS	P22
	7C28-004	4	PCS	P9~23		Si8-25	2	PCS	P23
	Z4.2-13	4	PCS	P9~21		7C26-031	2	PCS	P23
	J12	8	PCS	P11~25		M4-40	2	PCS	P24
	Z4.2-50	4	PCS	P18~23		Mi4-17	2	PCS	P24
	W04	4	PCS	P19~25		Za4.2-13	4	PCS	P24~30
	Z4.2-38	2	PCS	P21		T07	2	PCS	P26
	Z3.5-25	2	PCS	P21~24		Z4.8-25	2	PCS	P29

Part	NO.	QTY.				Length(MM)	Page
		3721	3722	3723	3724		
	354×1369	12	12	12	12	1369	P11
	479×1369	12	16	20	24	1369	P11
	318×206	4	4	4	4	318	P14~15
	354×423	4	4	4	4	423	P14~15
	354×643	4	4	4	4	643	P14~15
	354×856	4	4	4	4	856	P14~15
	479×1800	8	12	12	16	1800	P17
	479×909	4	4	8	8	909	P17
	664×1844	2	2	2	2	1844	P19
	1032×831	2	2	4	4	1032	P25

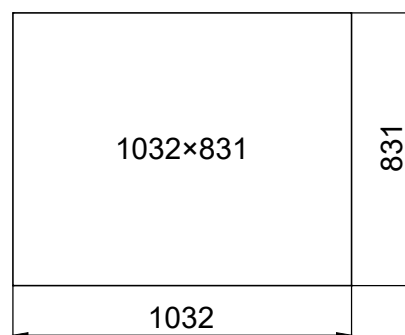
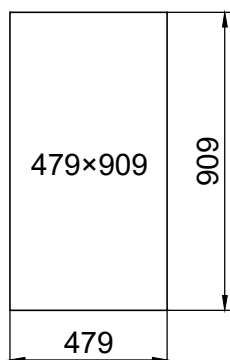
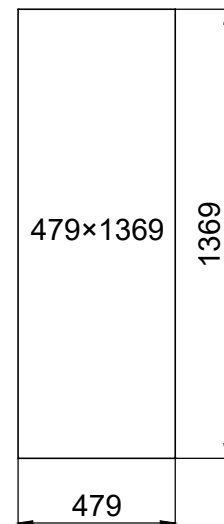
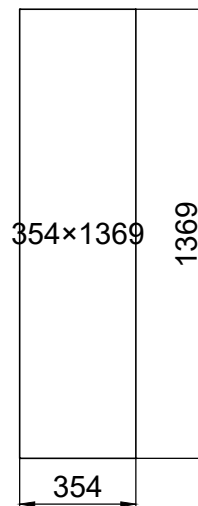
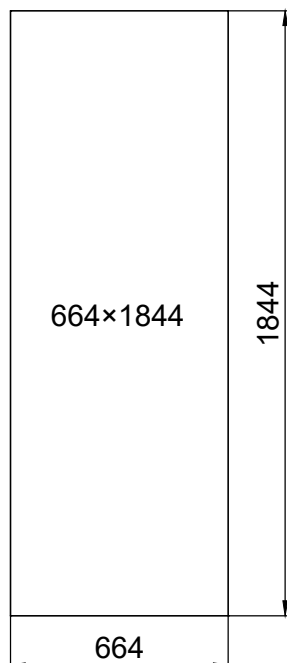
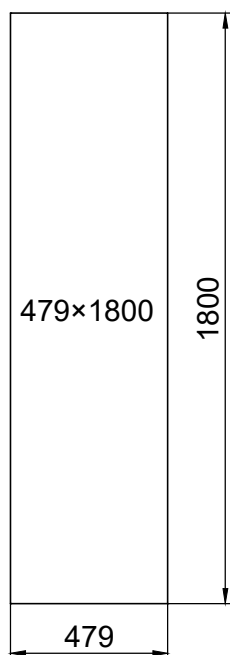
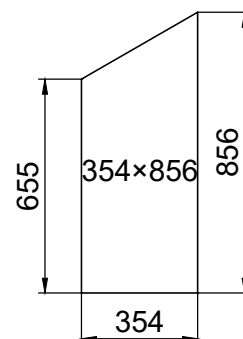
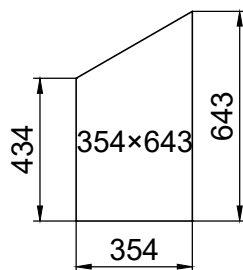
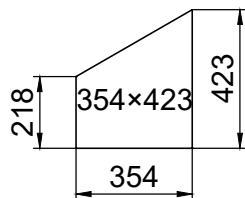
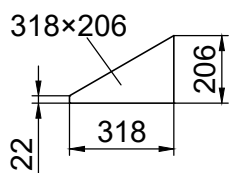

1g/30

Code	Length(MM)			
		3721	3722	3723
L	3204	4205	5206	6207

Sealing should be done to prevent frost from destroying the wall. The sealant between the wall and foundation of the greenroom is provided and handled by customers themselves.

Tätning bör göras för att muren ej skall frostsprängas. Tätning mellan mur och sockel står kunden själv för.

Tætningen bør gøres for at forhindre frostsprængninger i muren. Tætningen mellem mur og aluminiumprofil står kunden selv for

En tetning bør lages for å hindre frostsprengning av muren. Tetning mellom mur og sokkel ordnes av kunden selv

Tiivistys täytyy tehdä, jotta muuri ei hajoa pakkasella. Tiiviste muurin ja sokkelin välissä täytyy asiakkaan hoitaa itse

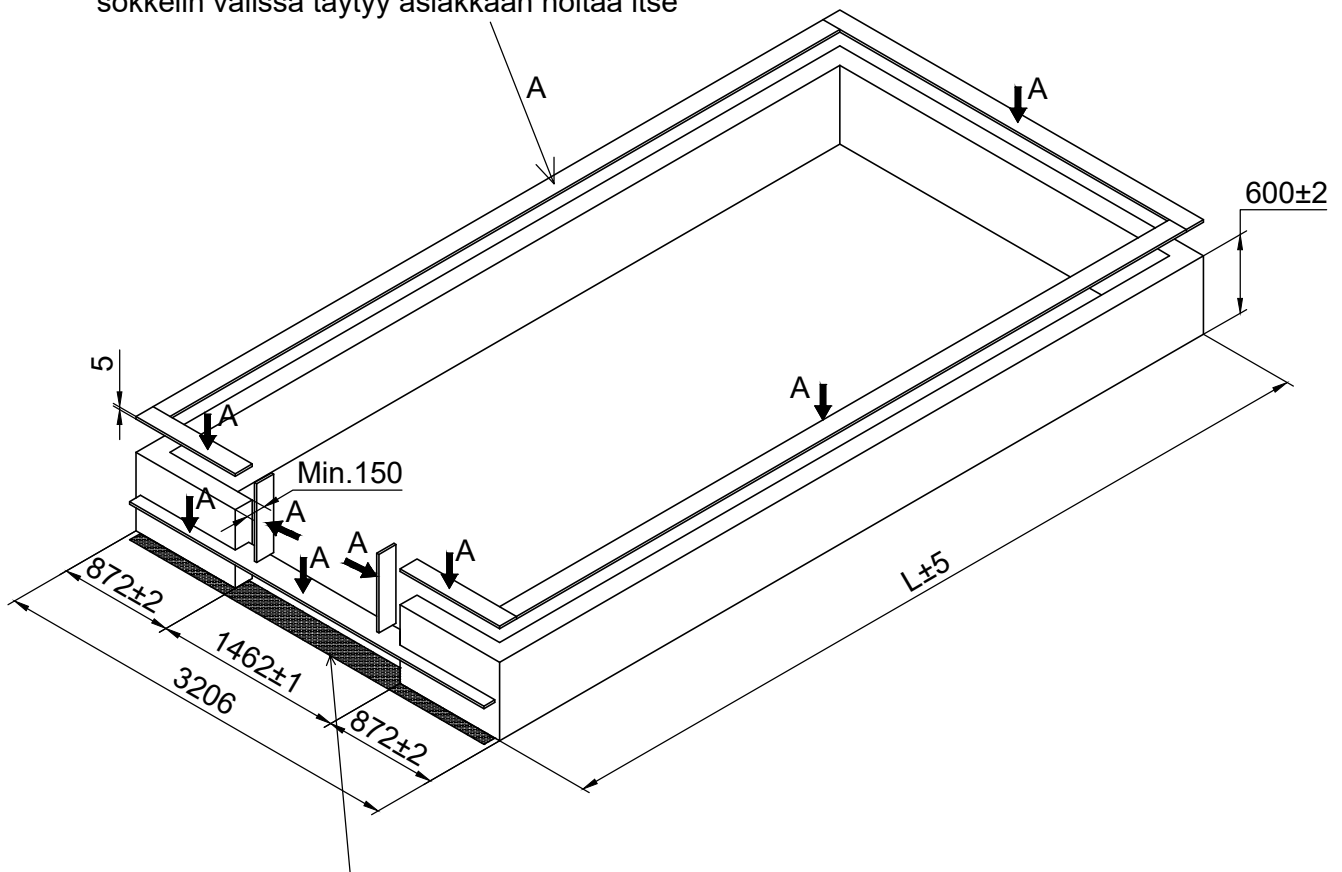

Make sure the floor below the doors frame should be flat and solid.

Se till att underlaget under dörrramen är plan och på solid grund.

Sørg for, at underlaget under dørkarmen er plan og på fast grund.

Sørg for at underlaget under dørterskelen er slett og på solid fundament.

Tarkista, että maa ovikarmin alla on sileä ja tasainen.

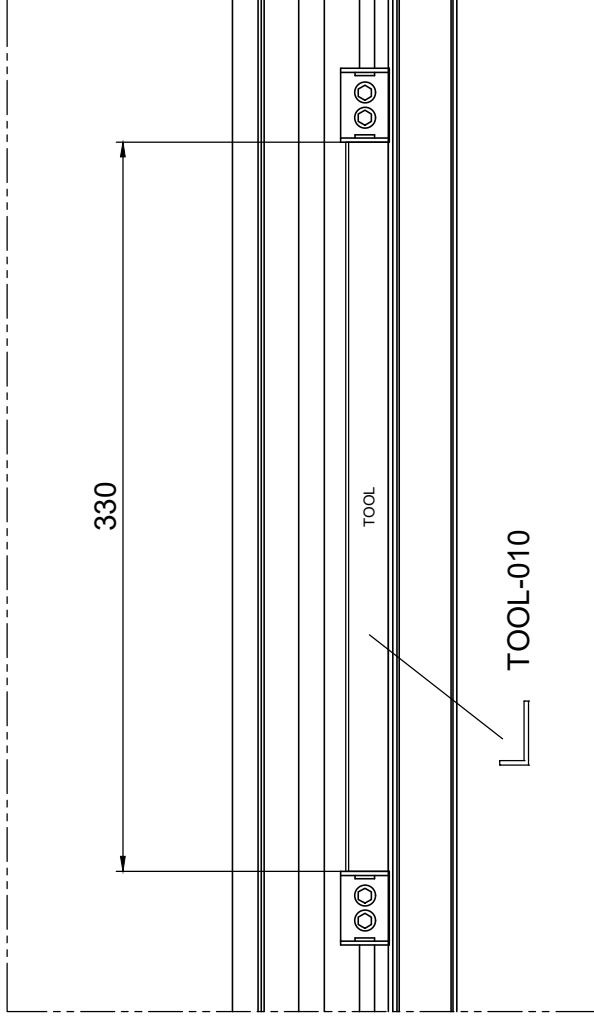

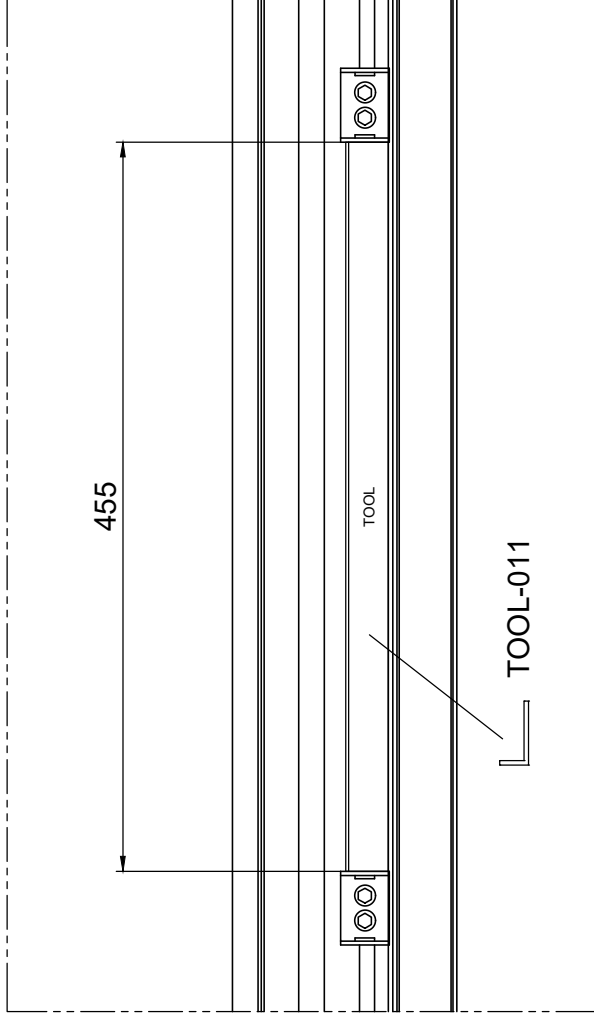

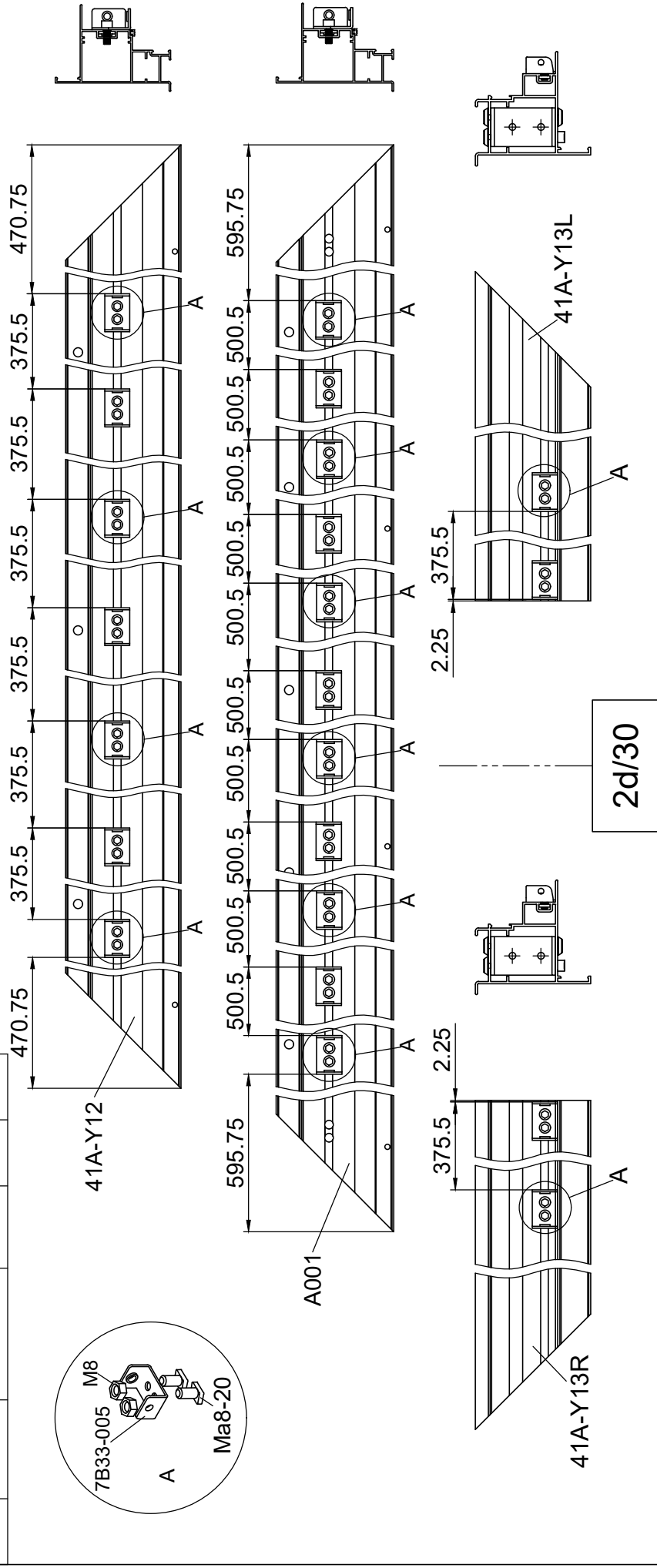

Part	NO.	QTY.	Length (MM)	QTY.								Length (MM)	
				3721		3722		3723		3724			
				SH2GA1- BSC-2	SH2GA1- EXTN-2	SH2GA1- BSC-2	SH2GA1- EXTN-2	SH2GA1- BSC-2	SH2GA1- EXTN-2	SH2GA1- BSC-2	SH2GA1- EXTN-2	SH2GA1- EXTW-2	SH2GA1- EXTW-2
	7B33-005	6	4	2	6	6	2	6	6	4	6	8	4
	Ma8-20	12	8	4	12	12	4	12	12	8	16	8	8
	M8	12	8	4	12	12	4	12	12	8	16	8	8

Part	Product	NO.	Length (MM)	QTY.	Code
	3721	41A-Y11-3	3238	2	A001
	3722	41A-Y11-4	4239		
	3723	41A-Y11-5	5240		
	3724	41A-Y11-6	6241		



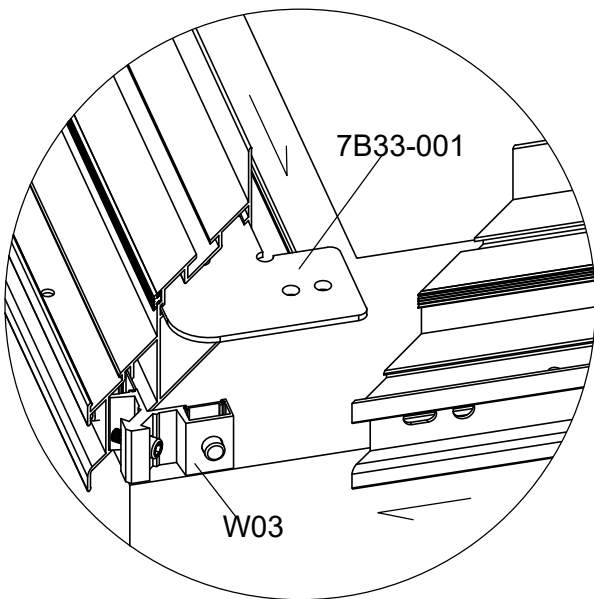
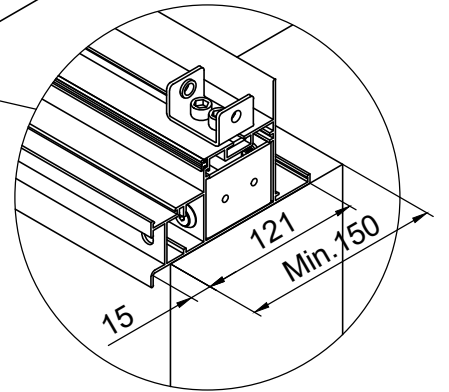
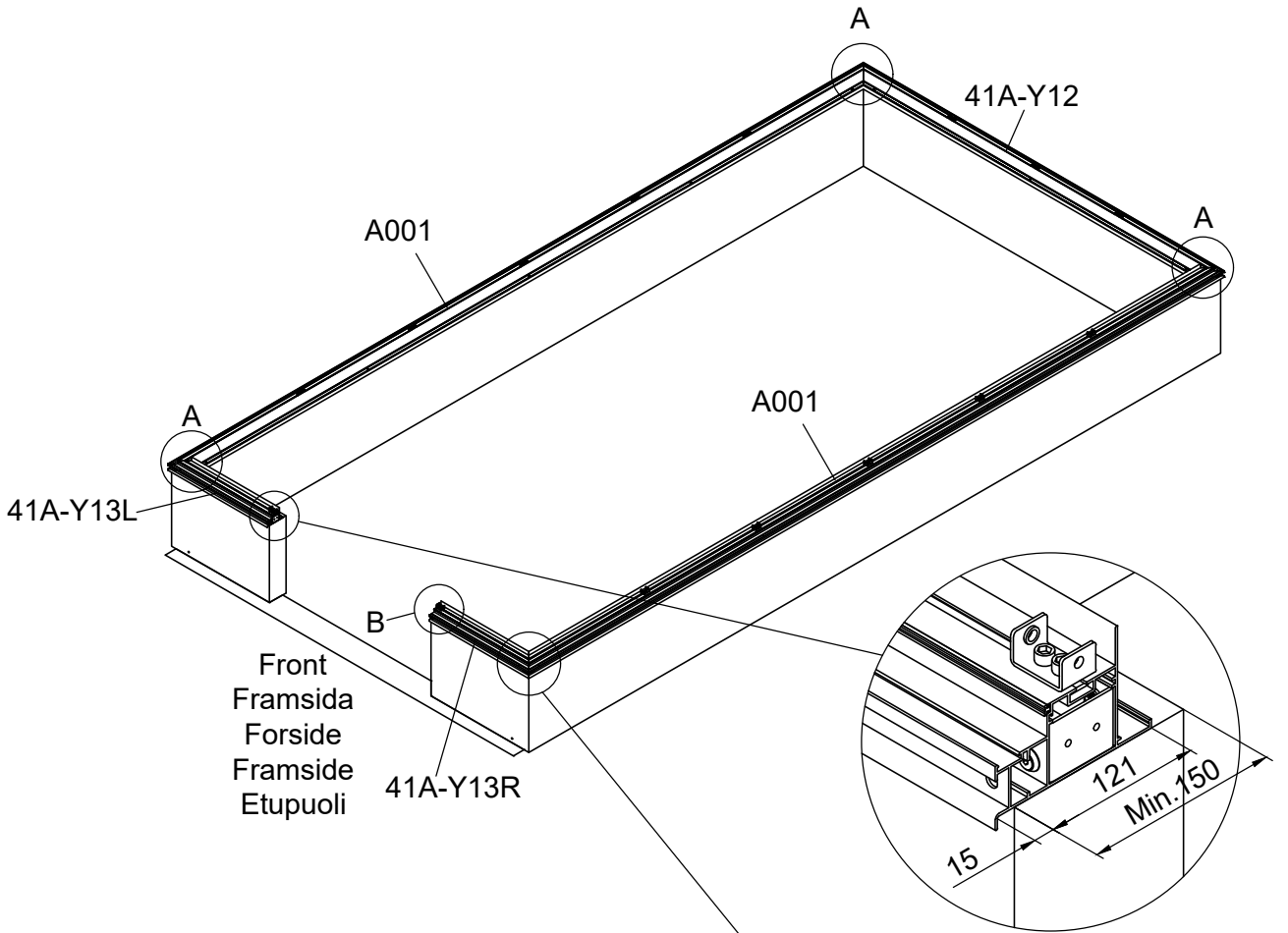

Part	NO.	QTY.	Length(MM)
	7B33-001	4	PCS
	W03	4	30

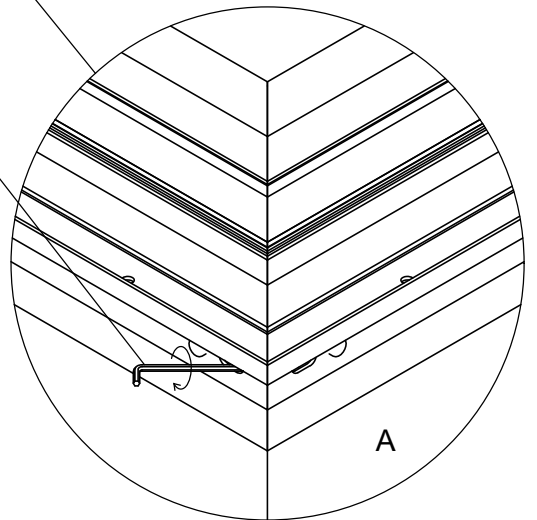
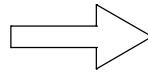

Tool
Verktøy
Værktøj
Verktøy
Työkalu

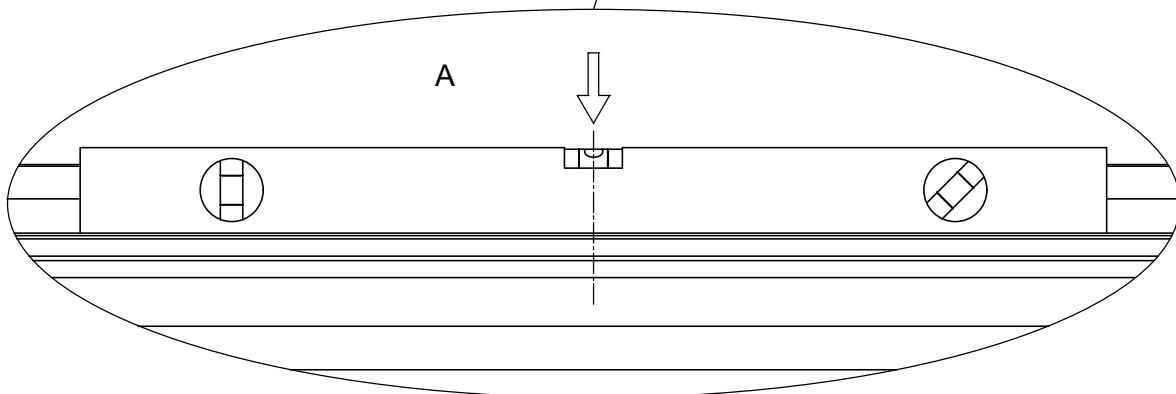
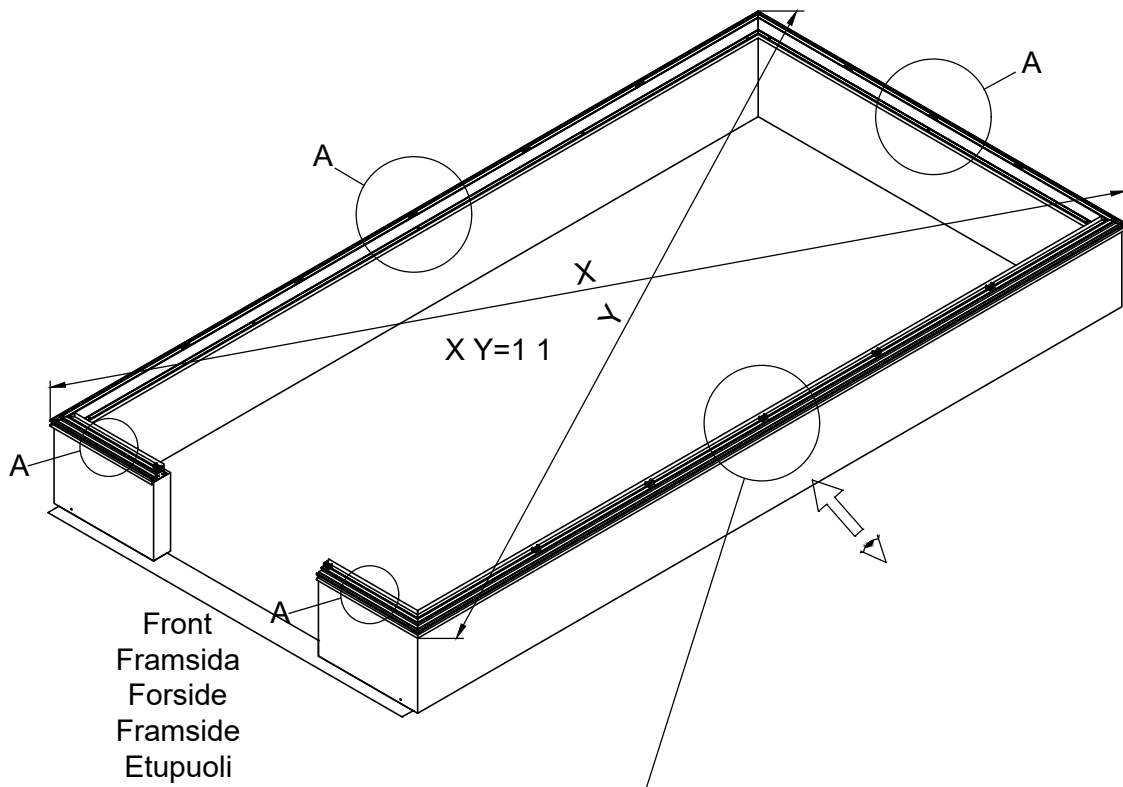





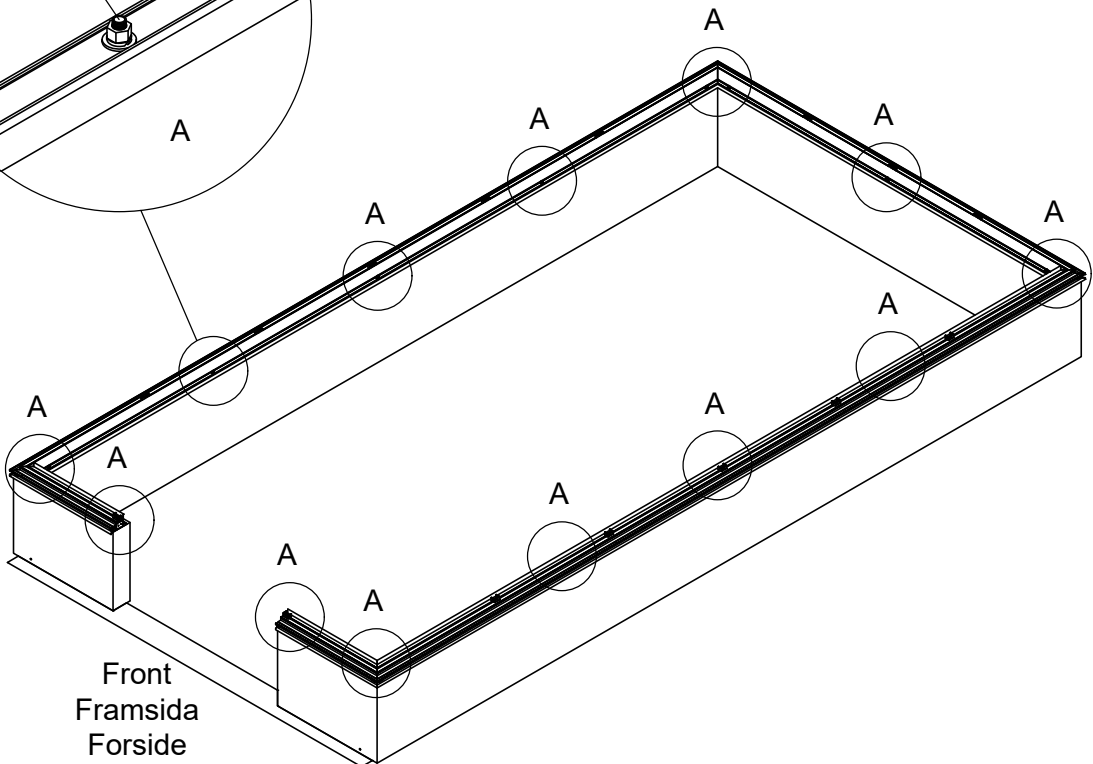
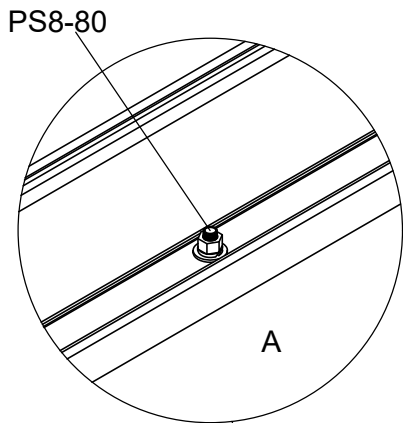
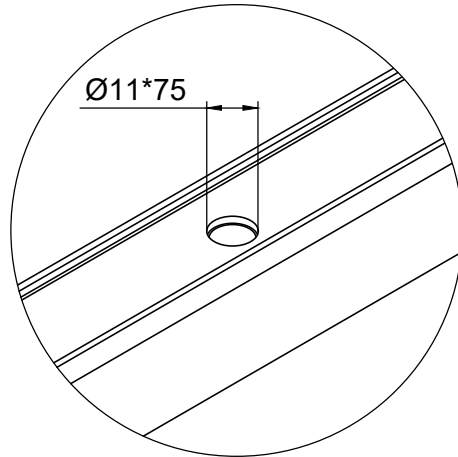
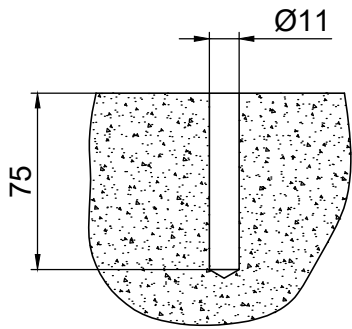

Part	NO.	QTY.	Length(MM)
	PS8-80	18	PCS





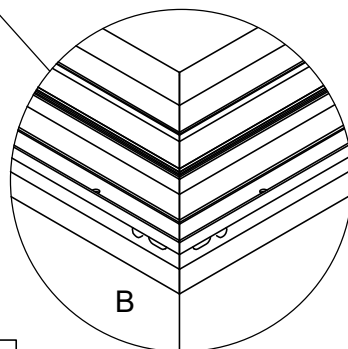
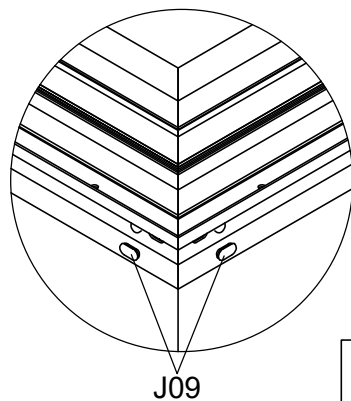
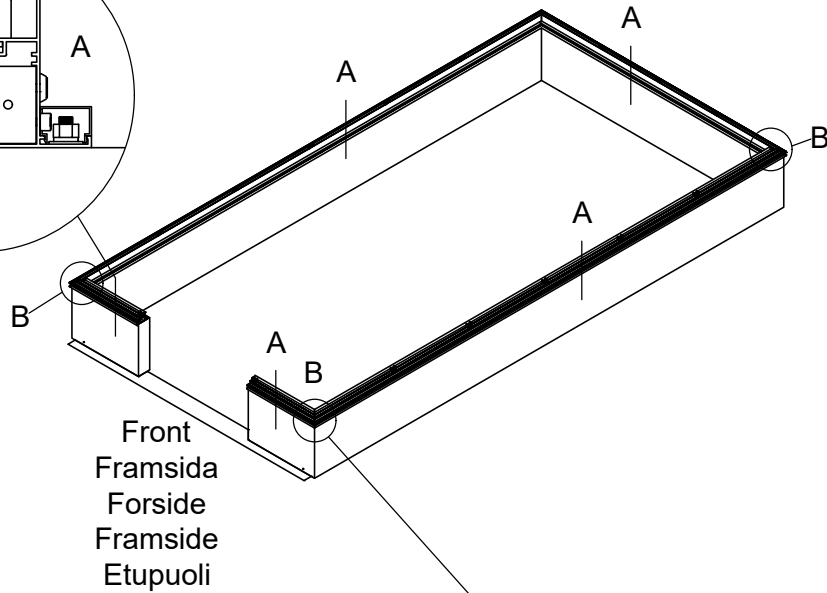
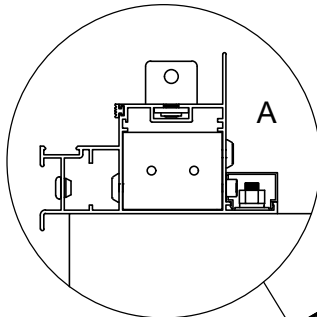
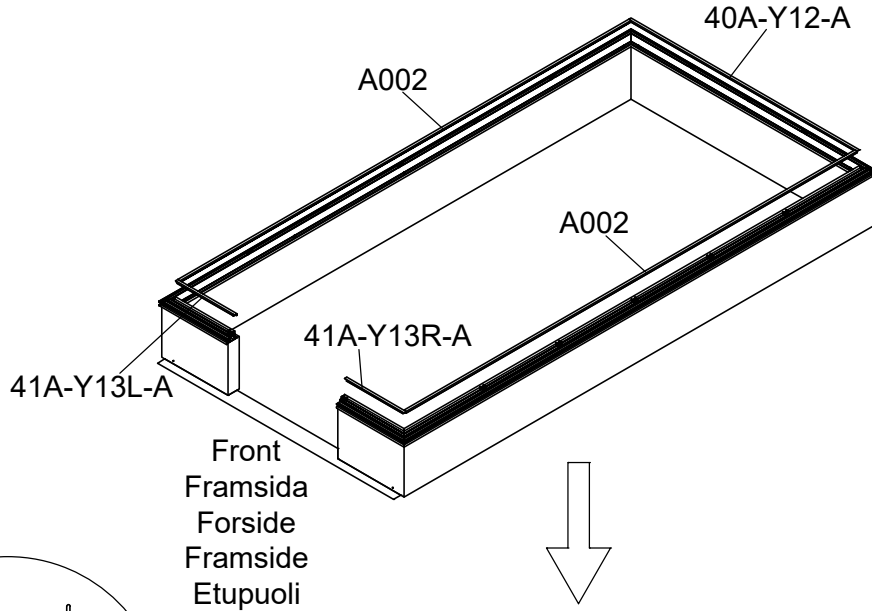

Front
 Framsida
 Forside
 Framside
 Etupuoli

Part	NO.	QTY.	Length(MM)
	40A-Y12-A	1	3022
	41A-Y13R-A	1	785
	41A-Y13L-A	1	785
	J09	8	PCS

Part	Product	NO.	Length(MM)	QTY.	Code
	3721	41A-Y11-4A	2691	2	A002
	3722	41A-Y11-4A	3962		
	3723	41A-Y11-5A	4963		
	3724	41A-Y11-6A	5964		







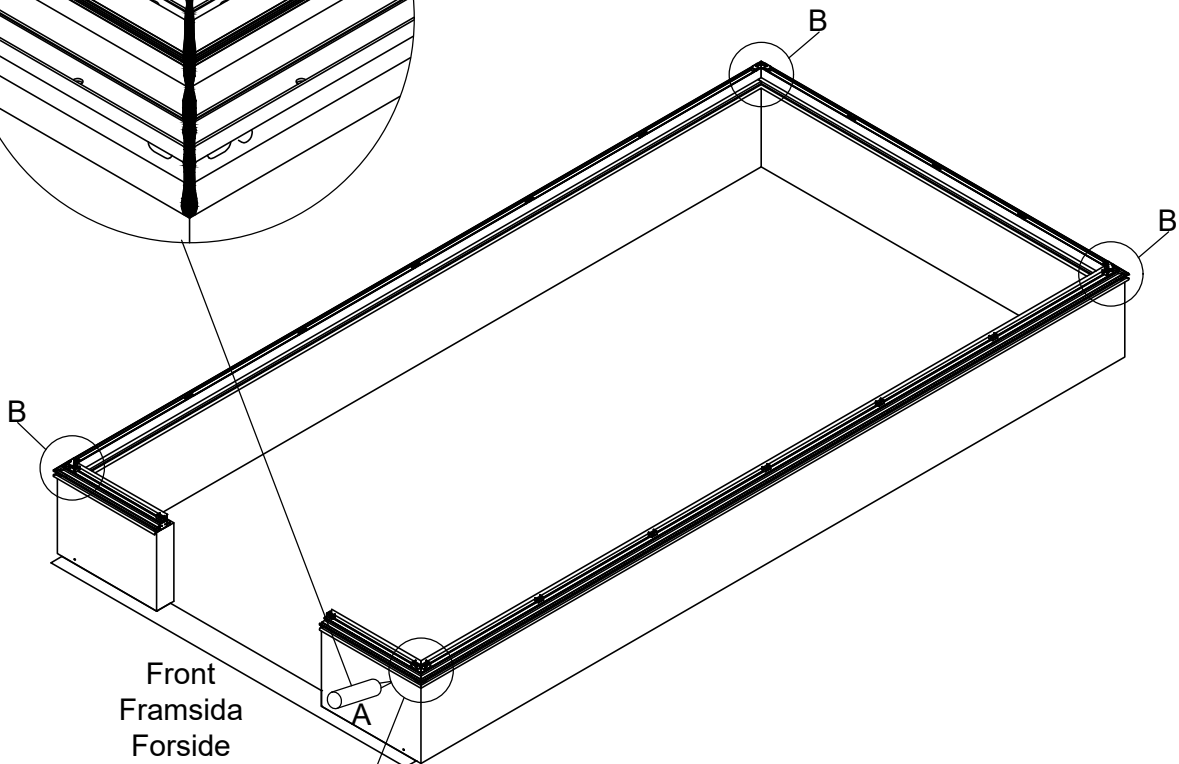
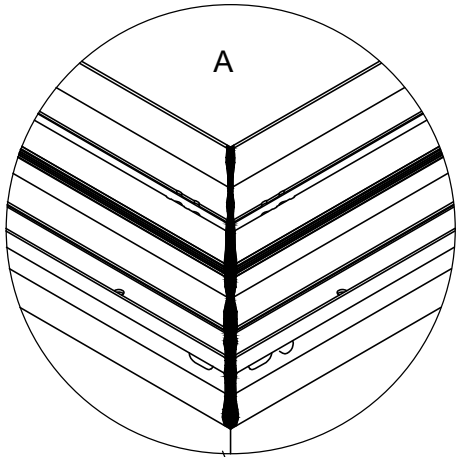

2h/30

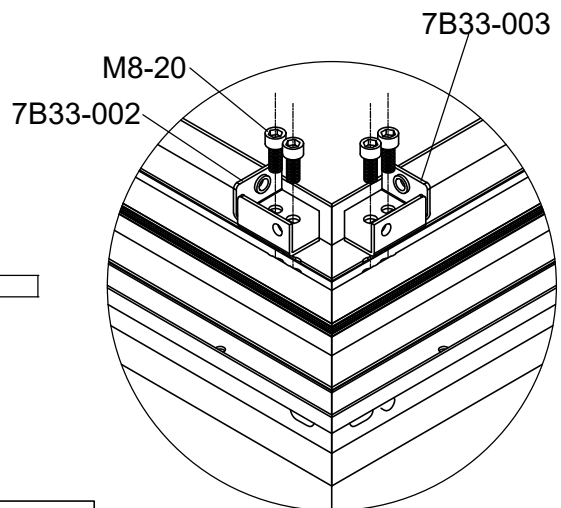
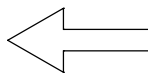
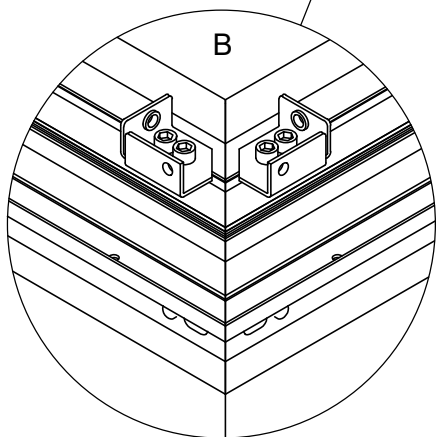
Part	NO.	QTY.	Length(MM)
	7B33-002	4	PCS
	7B33-003	4	PCS
	M8-20	16	PCS
	J08	1	PCS







Front
Framsida
Forside
Framsida
Etupuoli

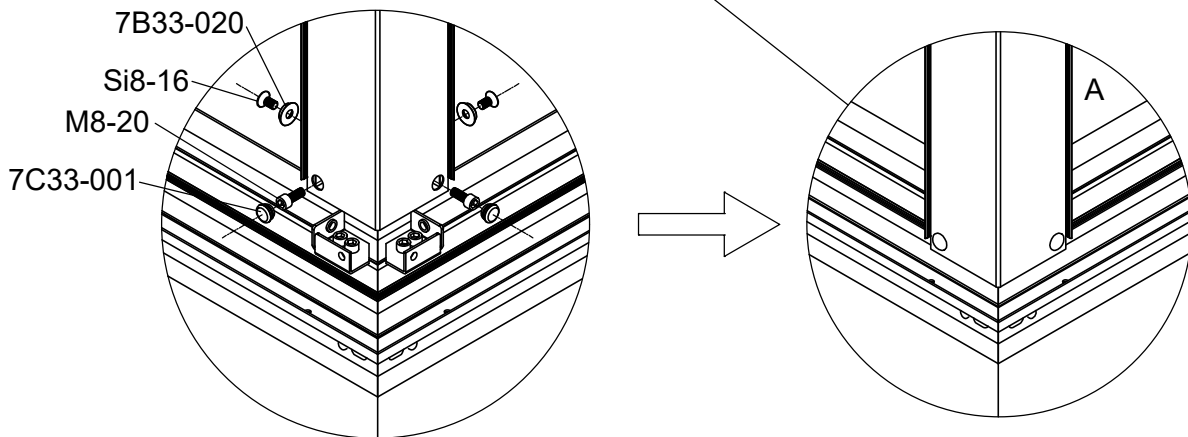
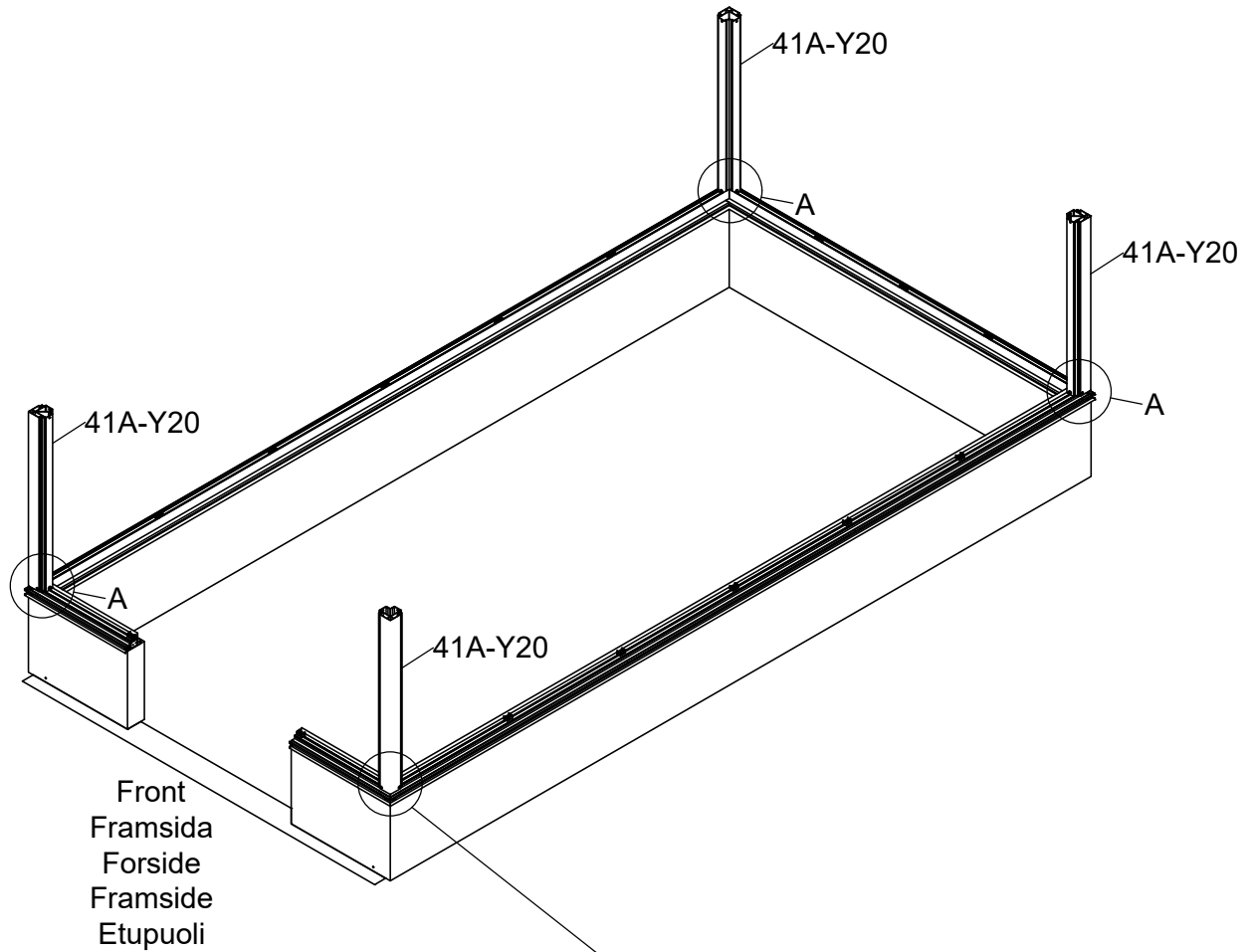





Part	NO.	QTY.	Length(MM)
	41A-Y20	4	1336
	Si8-16	8	PCS
	7B33-020	8	PCS
	M8-20	8	PCS
	7C33-001	8	PCS



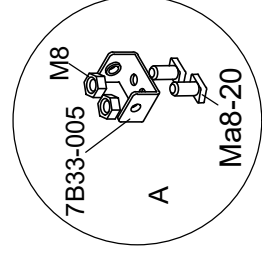
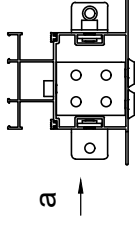
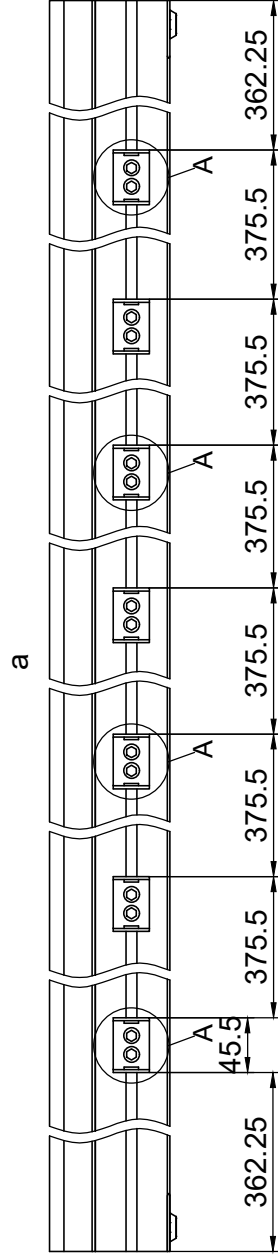
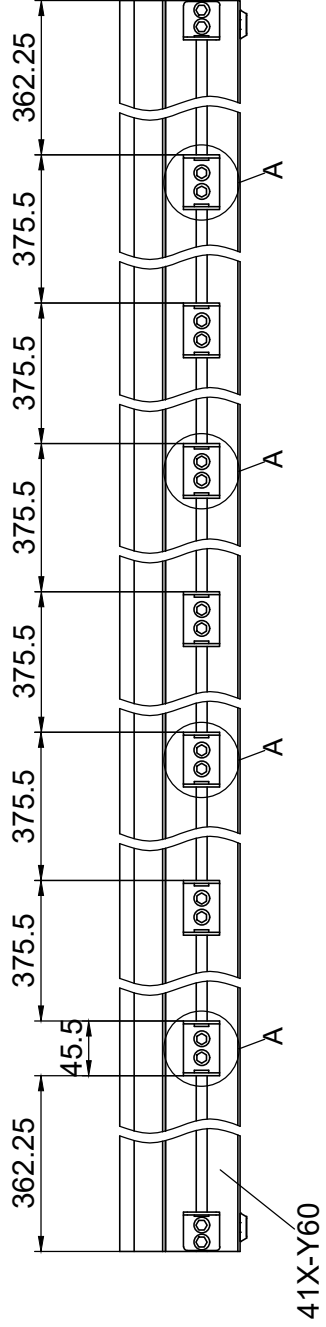



Part	NO.	QTY.	Length(MM)
	41X-Y60	1	3023

Part	NO.	QTY.	Length(MM)	CTN NO.
	7B33-005	8	PCS	SH2GA1-BSC-2
	Ma8-20	16	PCS	SH2GA1-BSC-2
	M8	16	PCS	SH2GA1-BSC-2

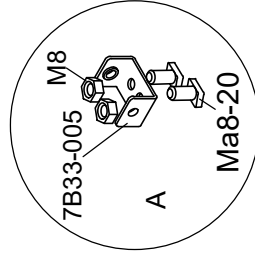
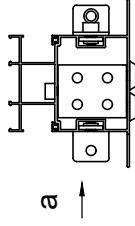
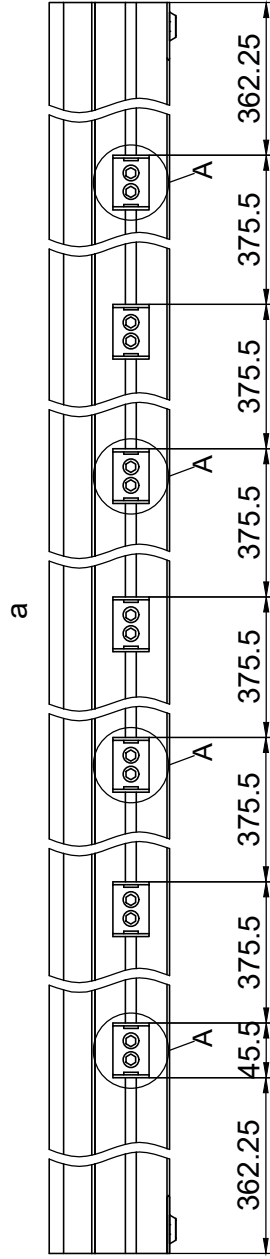
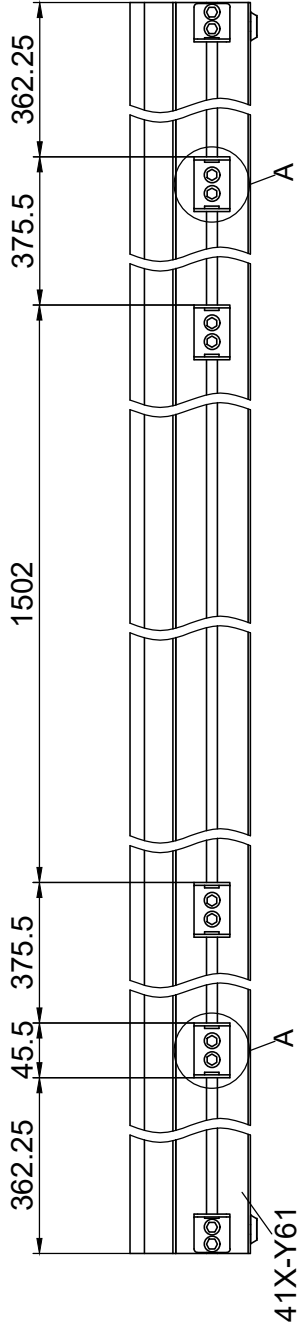



Part	NO.	QTY.	Length(MM)	Part	NO.	QTY.	Length(MM)	CTN NO.
	41X-Y61	1	3023		7B33-005	6	PCS	SH2GA1-BSC-2
					Ma8-20	12	PCS	SH2GA1-BSC-2
					M8	12	PCS	SH2GA1-BSC-2



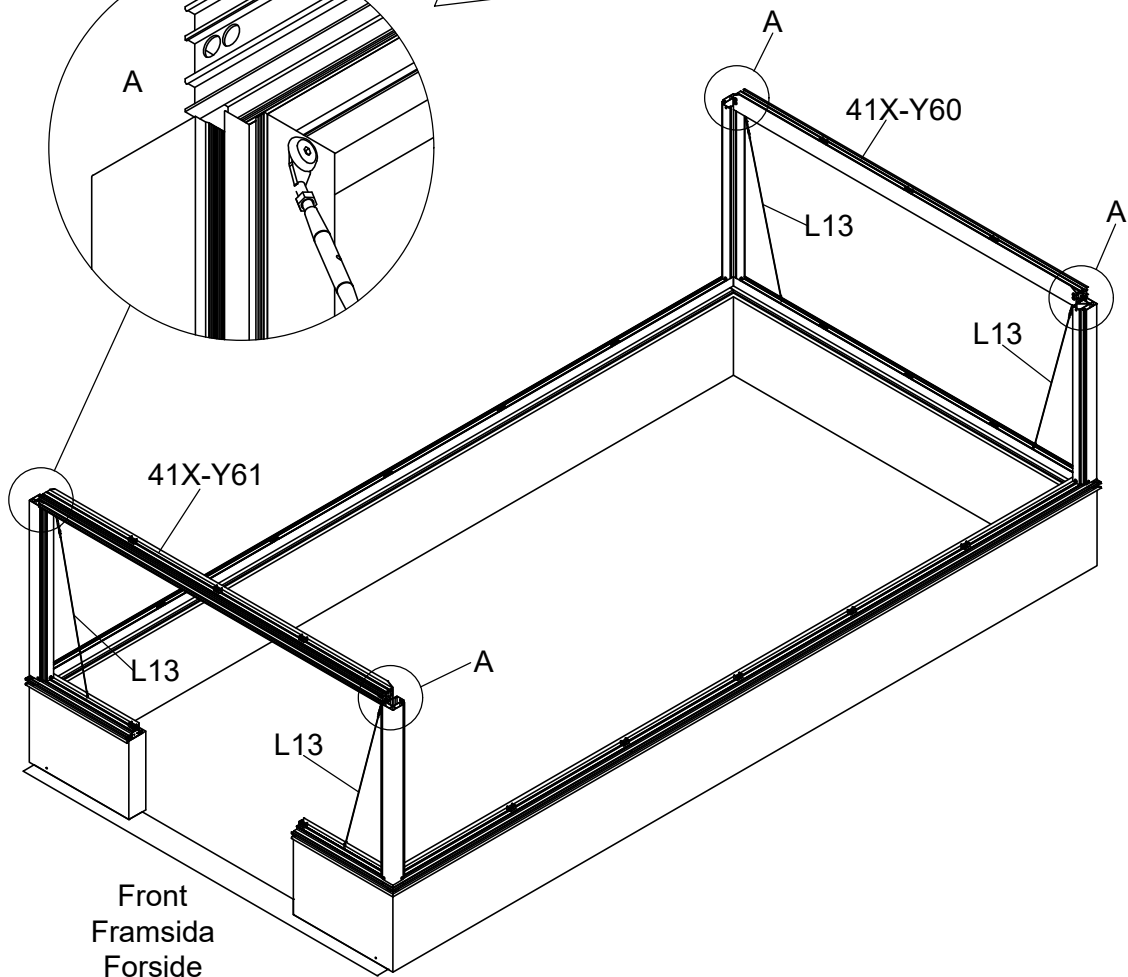
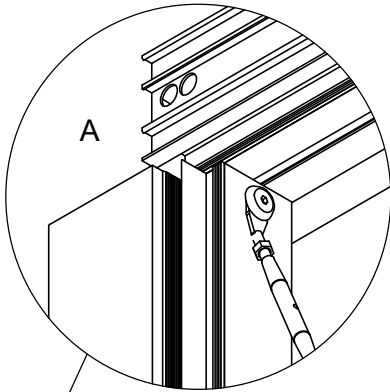
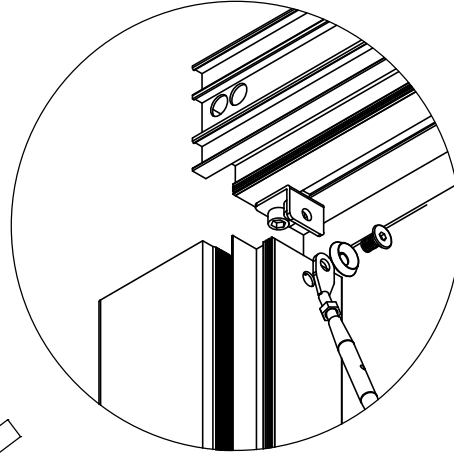



Part	NO.	QTY.	Length(MM)
	Si8-16	4	PCS
	7B33-020	4	PCS
	L13	4	1344

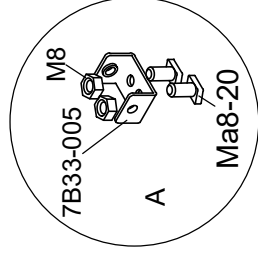
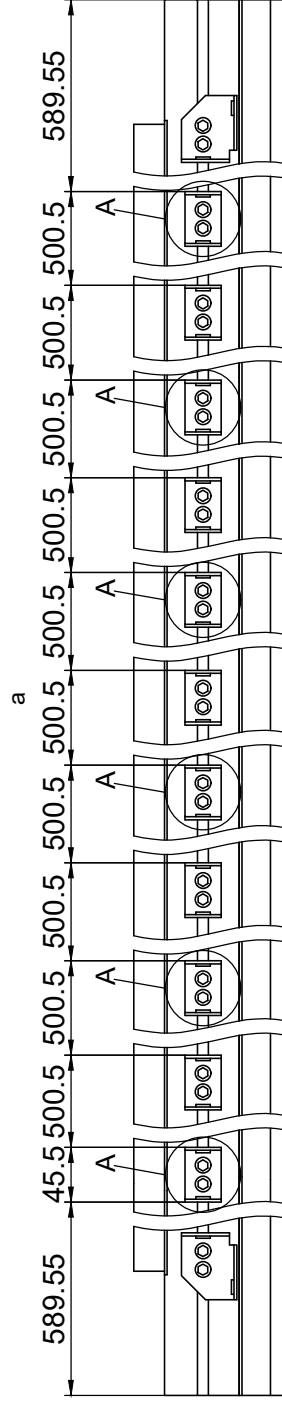
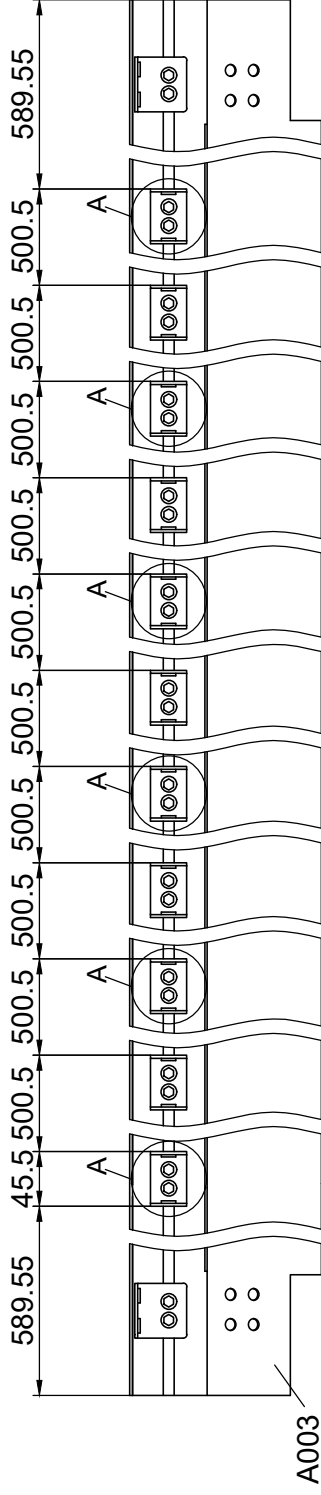

Front
 Framsida
 Forside
 Framside
 Etupuoli

Part	Product	NO.	Length(MM)	QTY.	Code	QTY.				Length (MM)											
						3721	3722	3723	3724												
  	3721	41X-Y62-3	3227	2	A003	SH2GA1-EXTN-2	SH2GA1-EXTW-2	SH2GA1-EXTN-2	SH2GA1-EXTW-2	SH2GA1-EXTN-2	SH2GA1-EXTW-2	8	4	12	4	12	8	16	8	8	PCS
	3722	41X-Y62-4	4228			Ma8-20	16	8	24	8	24	16	32	16	PCS						
	3723	41X-Y62-5	5229			M8	16	8	24	8	24	16	32	16	PCS						
	3724	41X-Y62-6	6230				16	8	24	8	24	16	32	16	PCS						



Part	NO.	QTY.	Length(MM)
	Si8-16	4	PCS
	7B33-020	4	PCS
	L14	4	1380

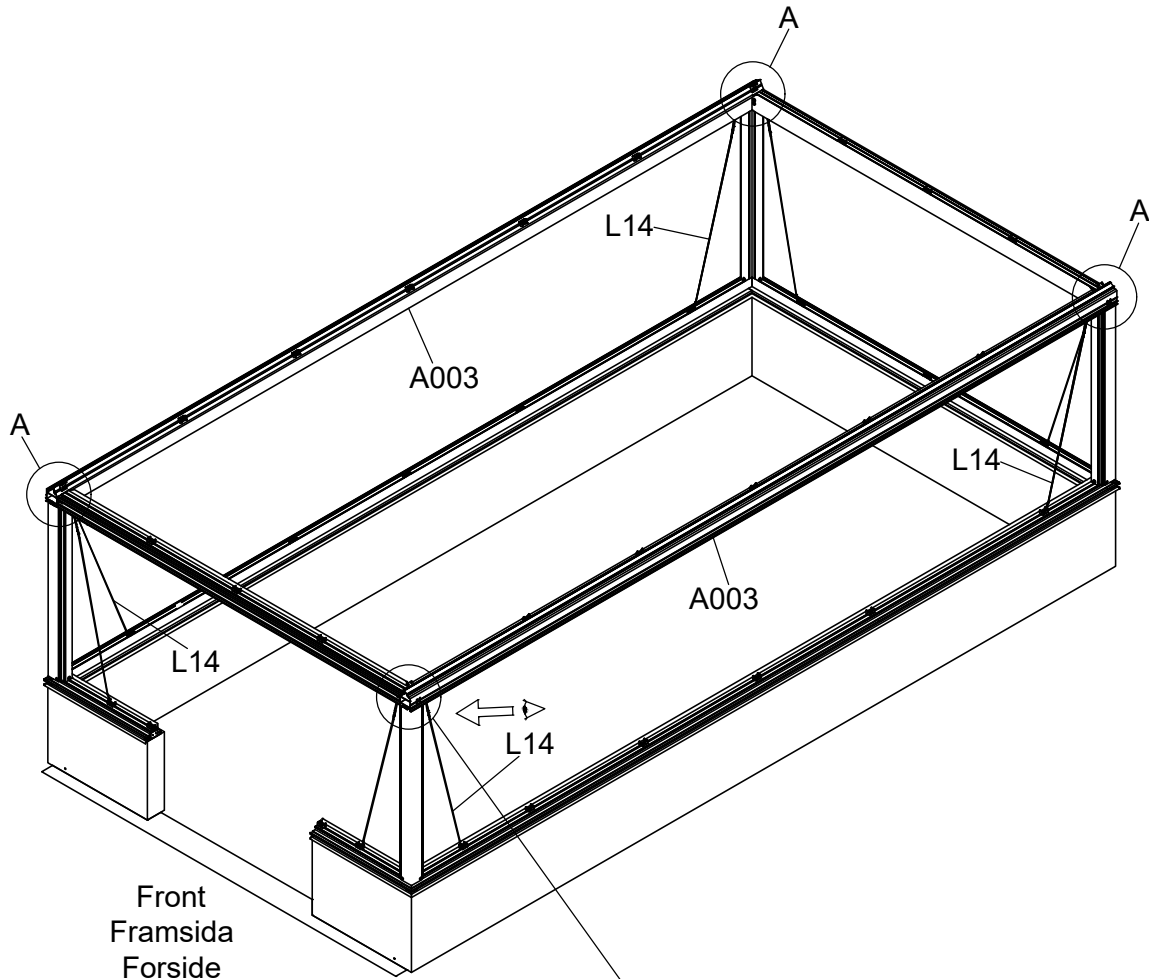

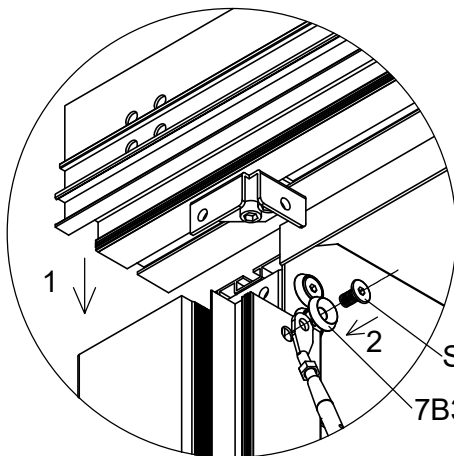

Front
Framsida
Forside
Framsida
Etupuoli

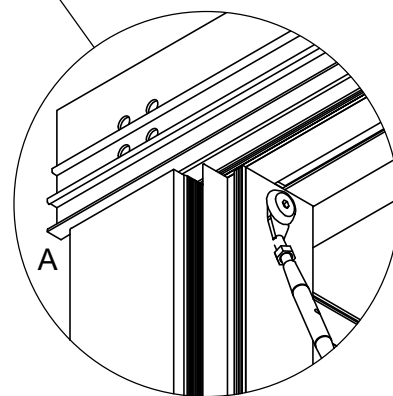
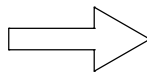

Si8-16
7B33-020



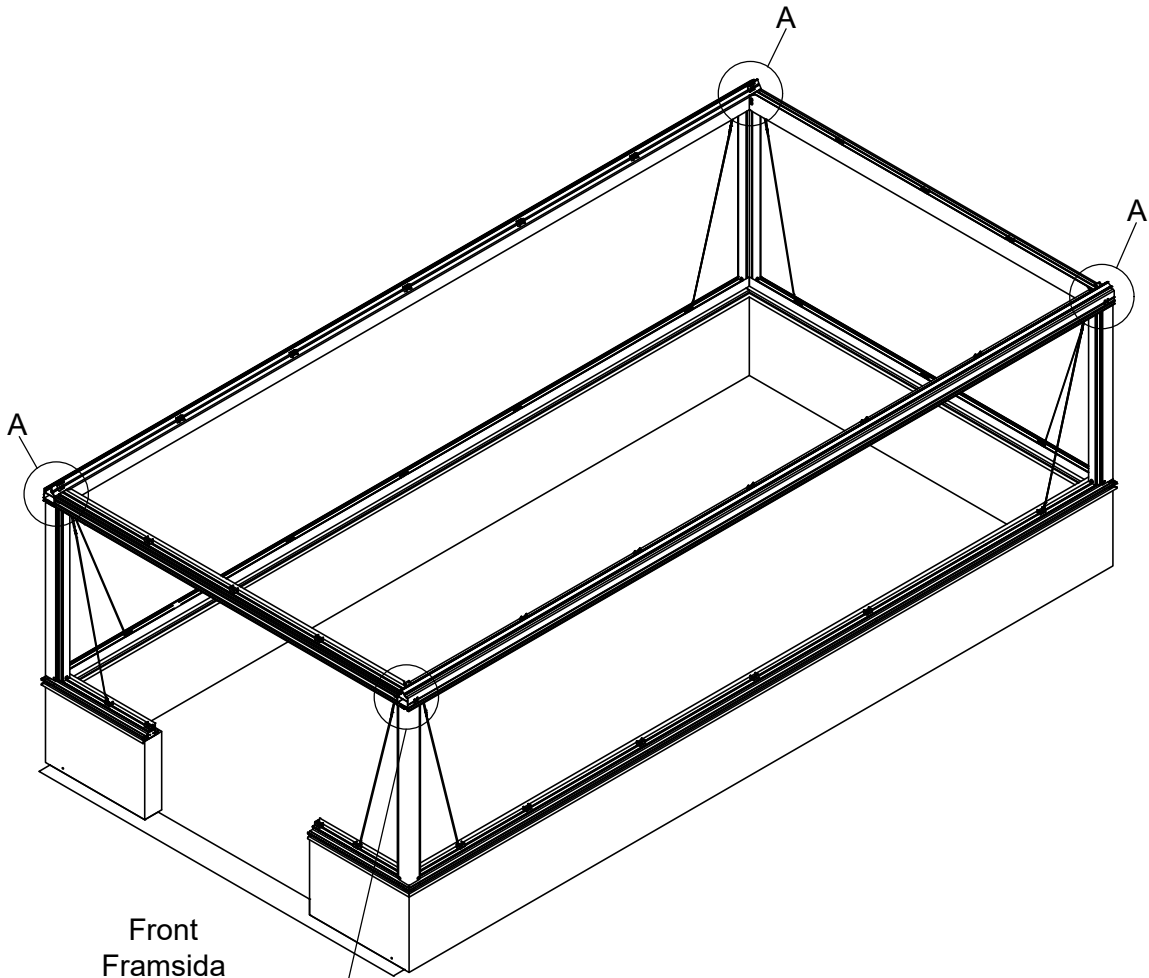

Part	NO.	QTY.	Length(MM)
	7B33-008	4	PCS
	M8-20	16	PCS

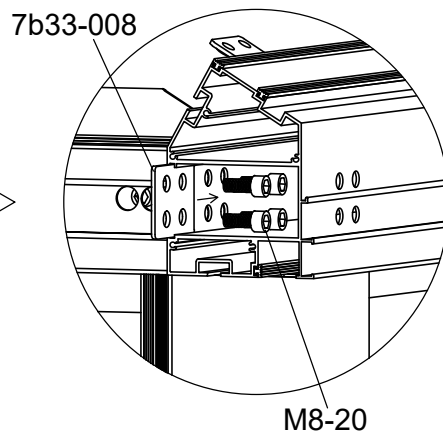
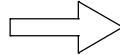
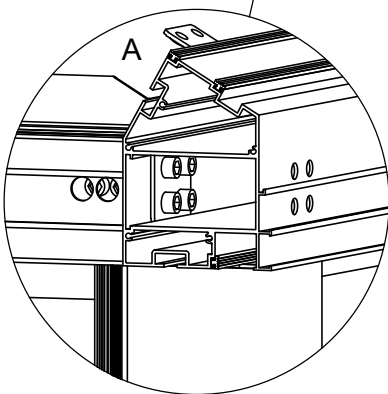

Front
 Framsida
 Forside
 Framside
 Etupuoli



Part	NO.	QTY.		Length (MM)
		SH2GA1-BSC-2	SH2GA1-EXTN-2	
	41A-Y30	4	4	1335
	Si8-16	8	8	PCS
	7B33-020	8	8	PCS

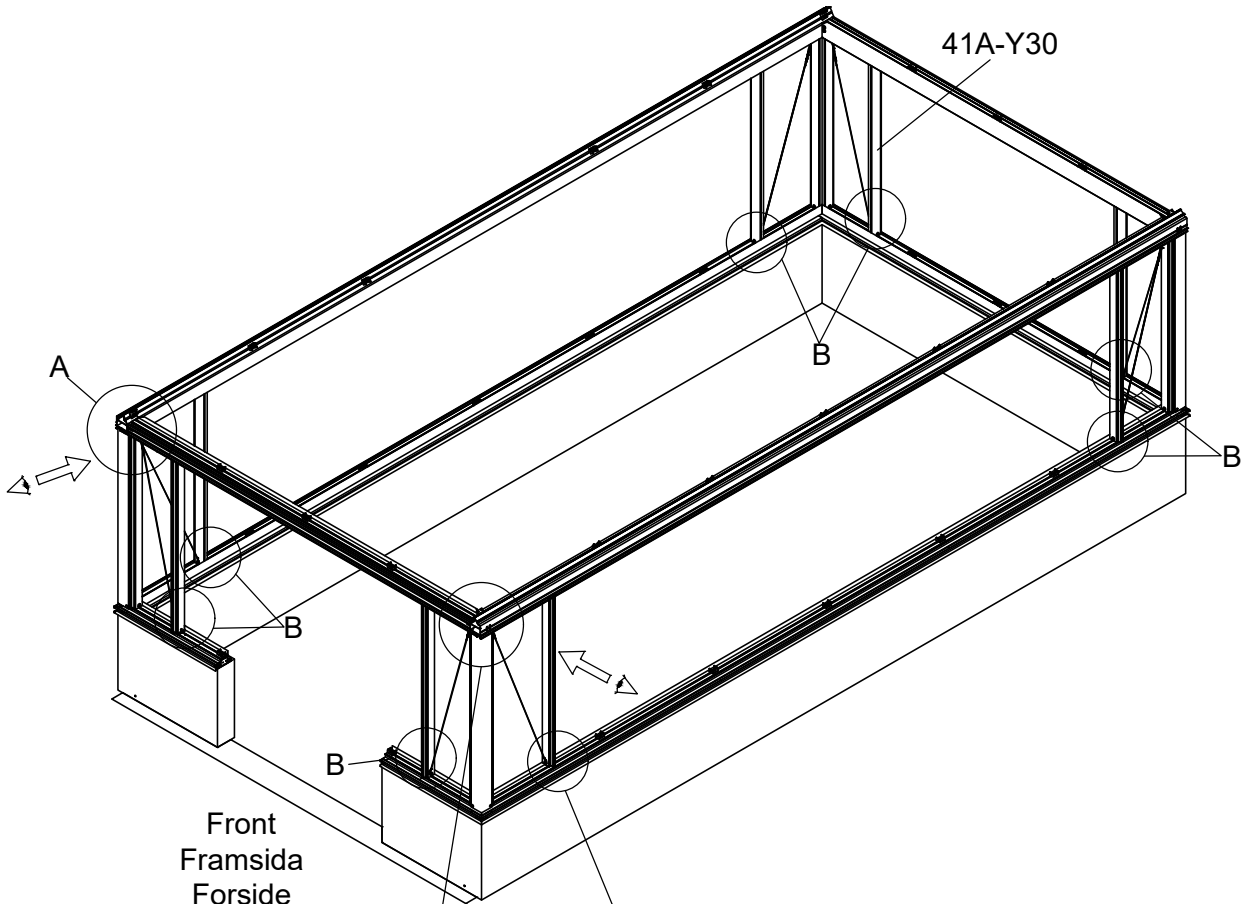

Front
Framsida
Forside
Framsida
Etupuoli

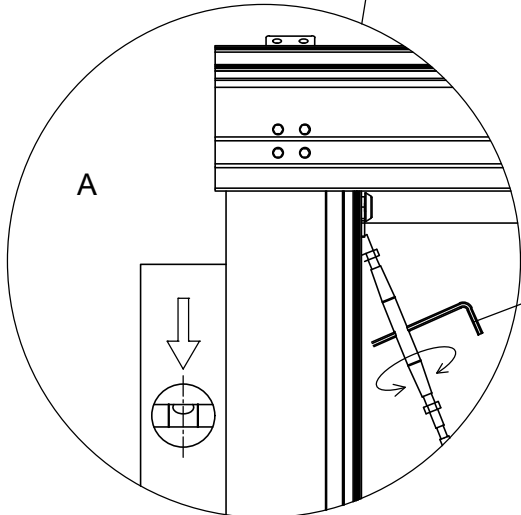
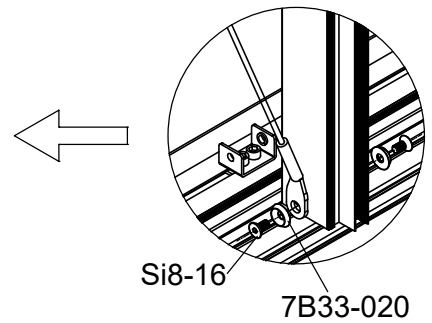
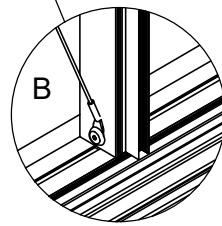



Tool
Verktøy
Værktøj
Verktøy
Työkalu

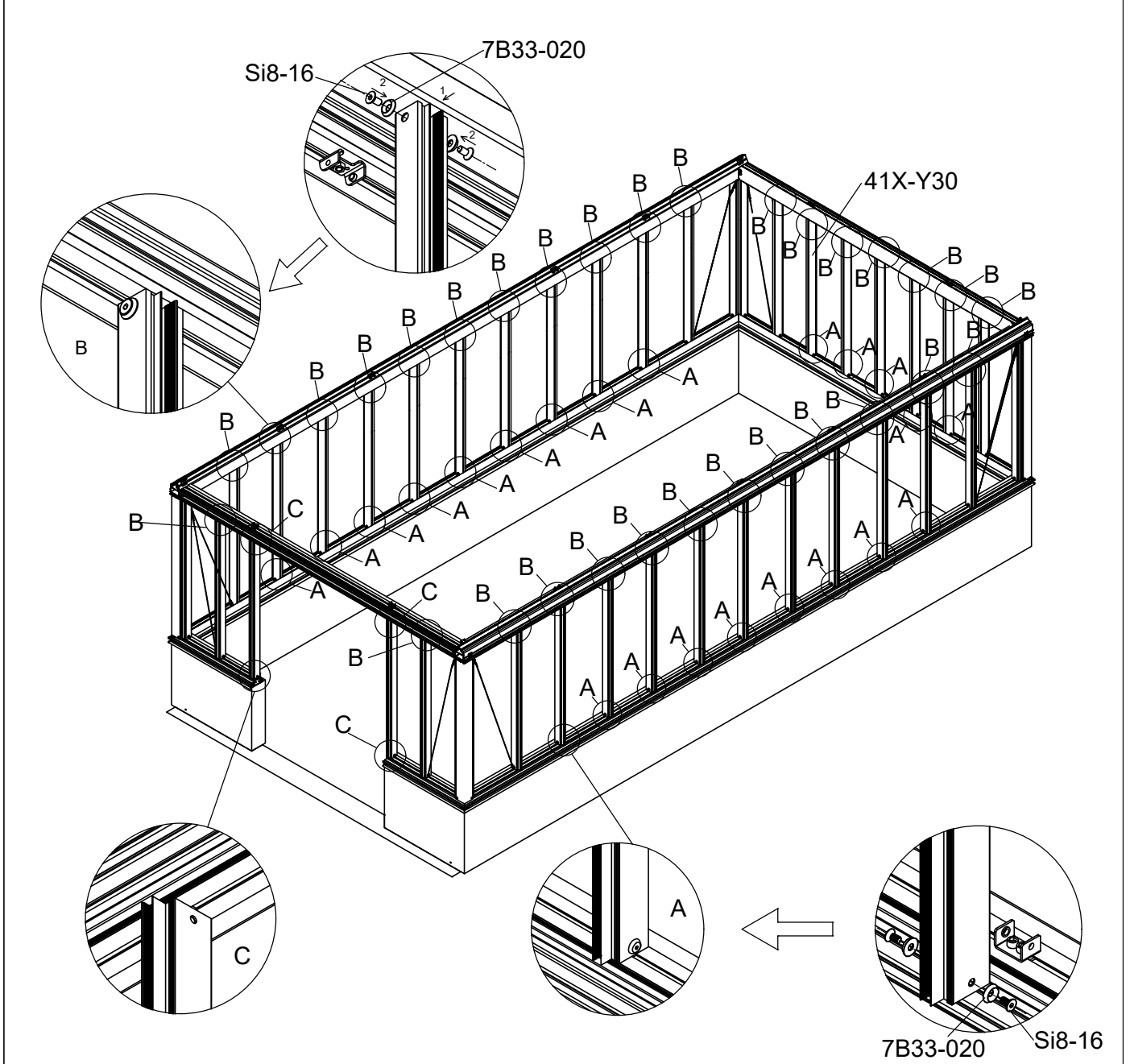



Part	NO.	QTY.																Length (MM)
		3721			3722			3723			3724							
		3721	SH2GA1-BSC-2	SH2GA1-EXTN-2	SH2GA1-EXTW-2	3722	SH2GA1-BSC-2	SH2GA1-EXTN-2	SH2GA1-EXTW-2	3723	SH2GA1-BSC-2	SH2GA1-EXTN-2	SH2GA1-EXTW-2	3724	SH2GA1-BSC-2	SH2GA1-EXTN-2	SH2GA1-EXTW-2	
	41X-Y30	9	2	0	2	11	2	2	2	13	2	2	4	15	2	4	4	1335
	Si8-16	32	16	8	8	40	16	16	8	48	16	16	16	56	16	24	16	PCS
	7B33-020	32	16	8	8	40	16	16	8	48	16	16	16	56	16	24	16	PCS



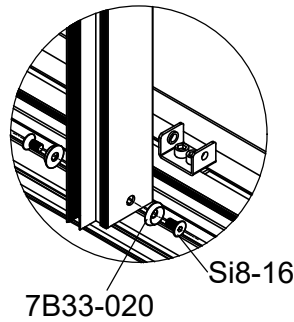
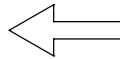
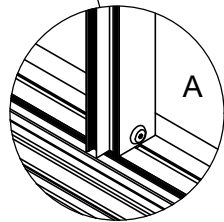
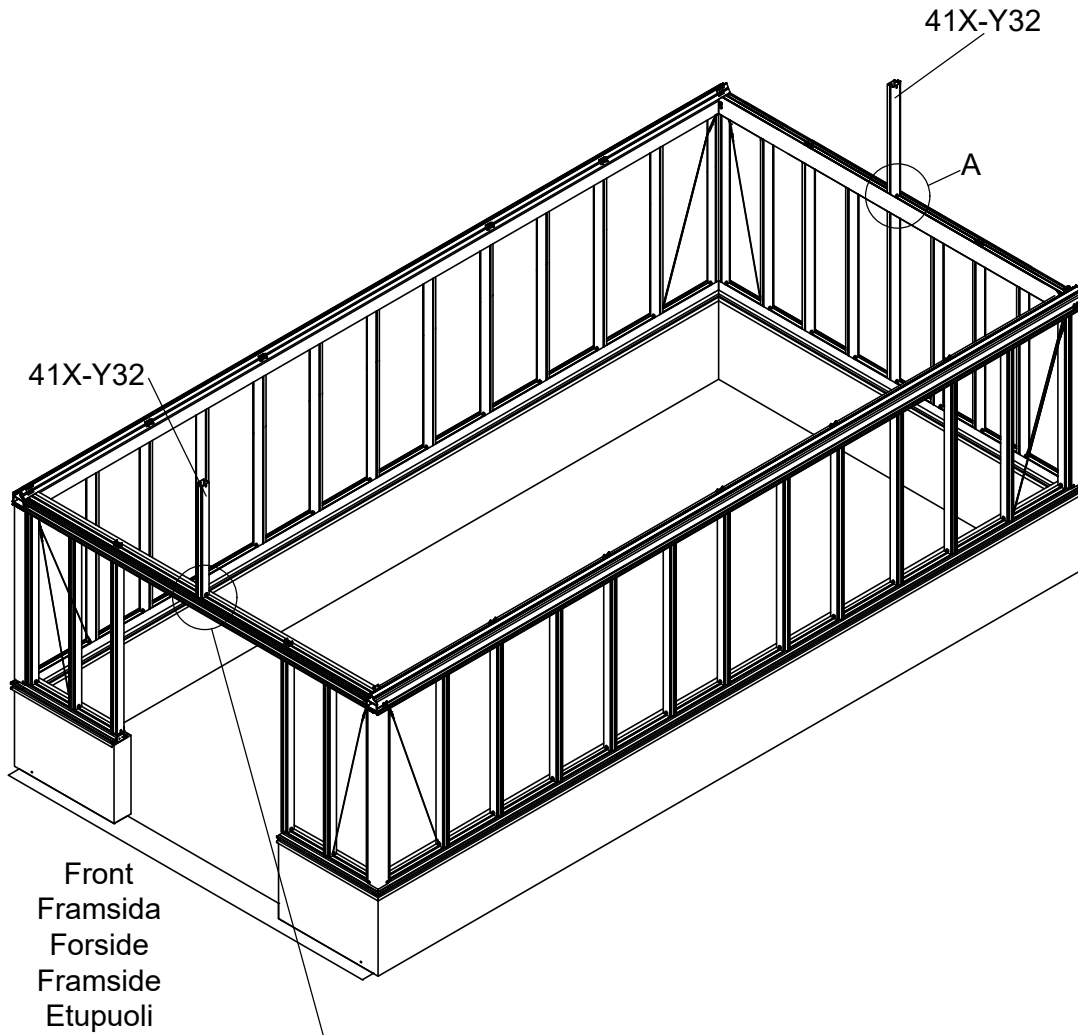

3721	3722	3723	3724

Part	NO.	QTY.	Length(MM)
	41X-Y32	2	857
	Si8-16	4	PCS
	7B33-020	4	PCS

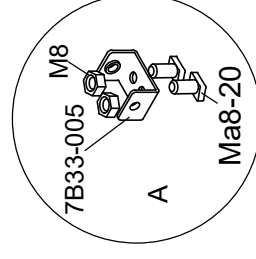
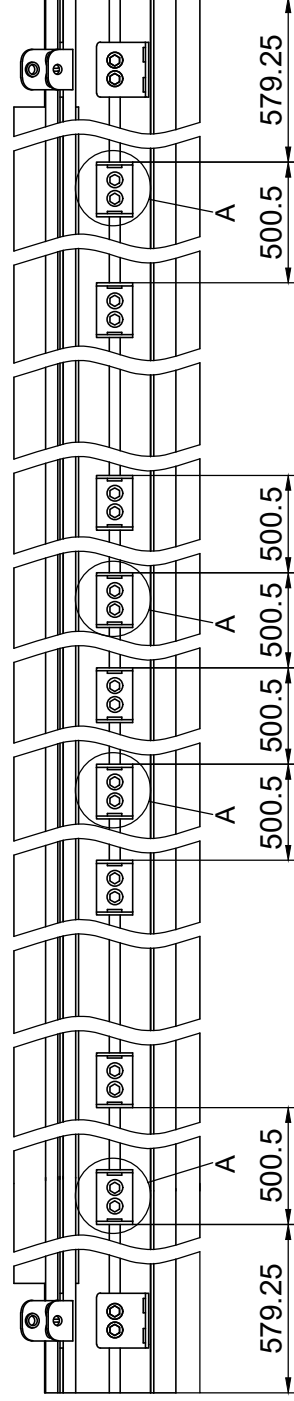
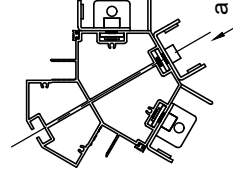
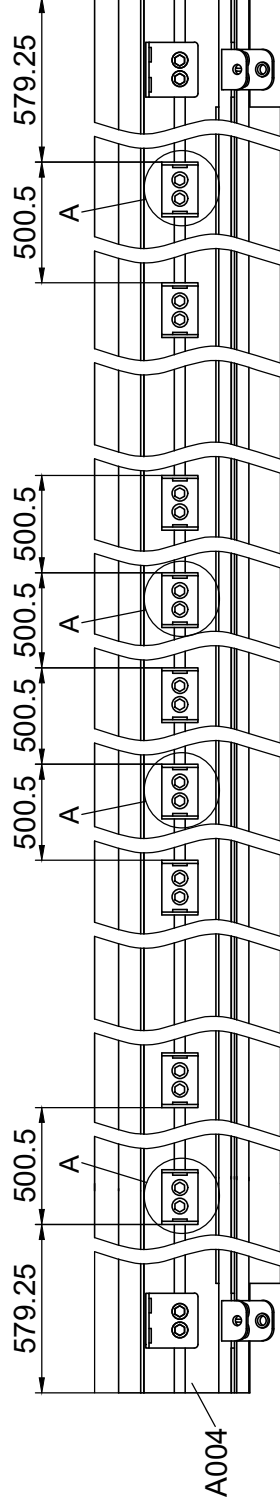

Part	Product	NO.	Length(MM)	QTY.	Code	Part	NO.	QTY.				Length(MM)	CTN NO.
								3721	3722	3723	3724		
	3721	41X-Y63-3	3206	1	A004		7B33-005	4	6	6	8	PCS	SH2GA1-EXTN-2
	3722	41X-Y63-4	4207				Ma8-20	8	12	12	16	PCS	SH2GA1-EXTN-2
	3723	41X-Y63-5	5208				M8	8	12	12	16	PCS	SH2GA1-EXTN-2
	3724	41X-Y63-6	6209										





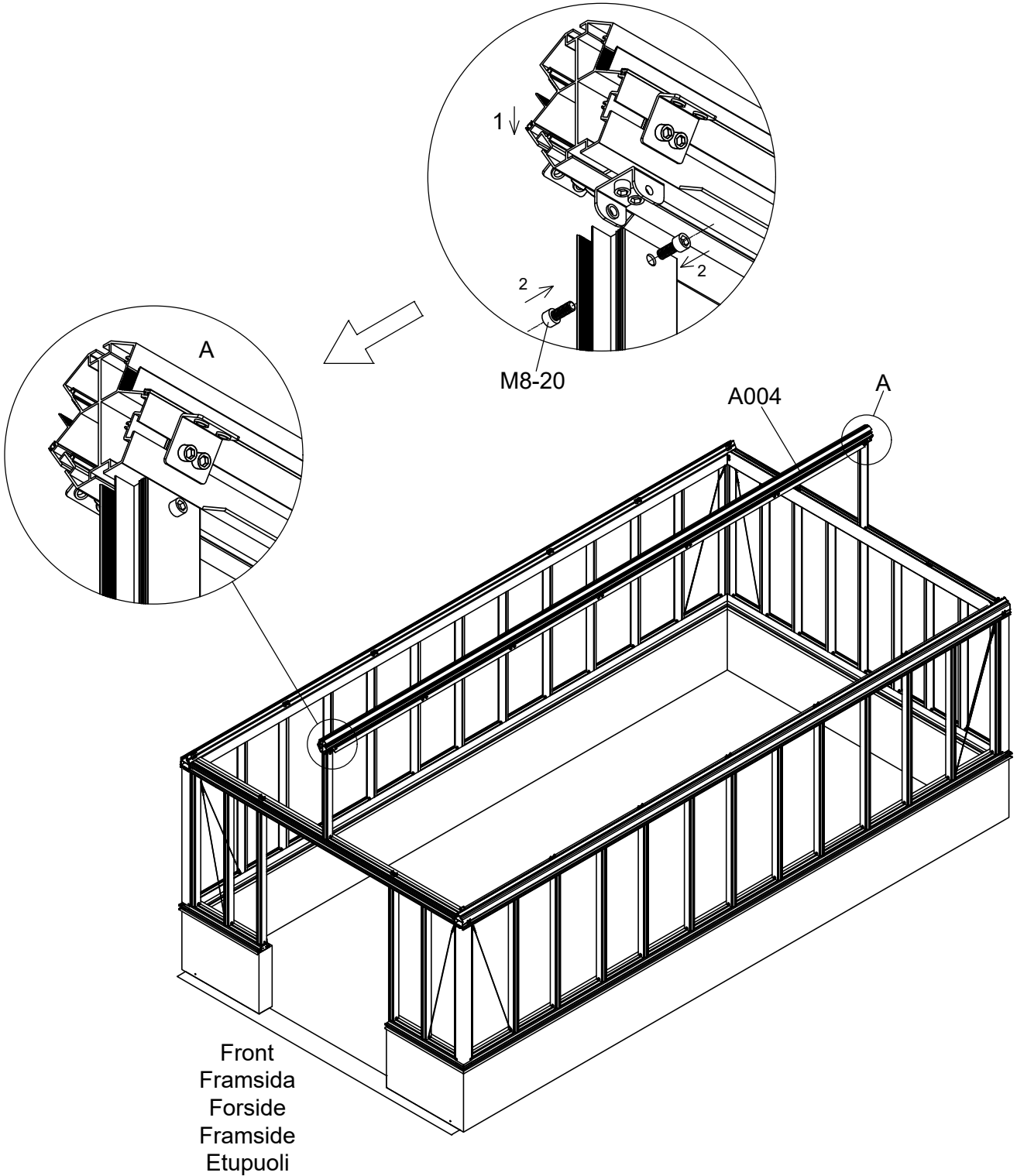

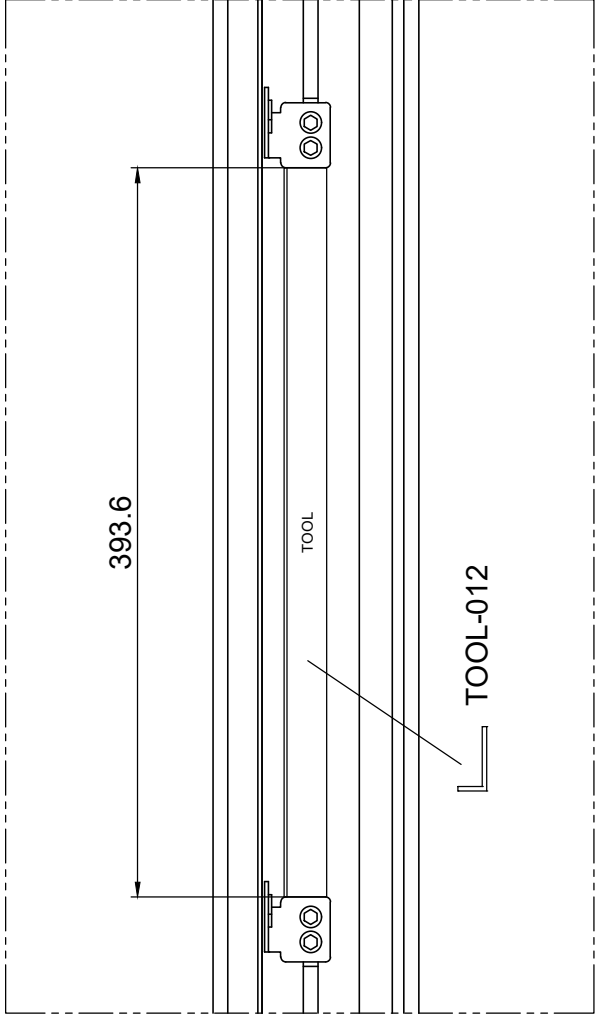

Part	NO.	QTY.	Length(MM)
	M8-20	4	PCS



Front
 Framside
 Forside
 Framside
 Etupuoli



Part	NO.	QTY.	Length(MM)
	41X-Y21	2	1715
	41X-Y22	2	1715

Part	NO.	QTY.	Length(MM)	CTN NO.
	7B33-013R	4	PCS	SH2GA1-BSC-2
	7B33-013L	4	PCS	SH2GA1-BSC-2
	Ma8-20	8	PCS	SH2GA1-BSC-2
	M8	8	PCS	SH2GA1-BSC-2

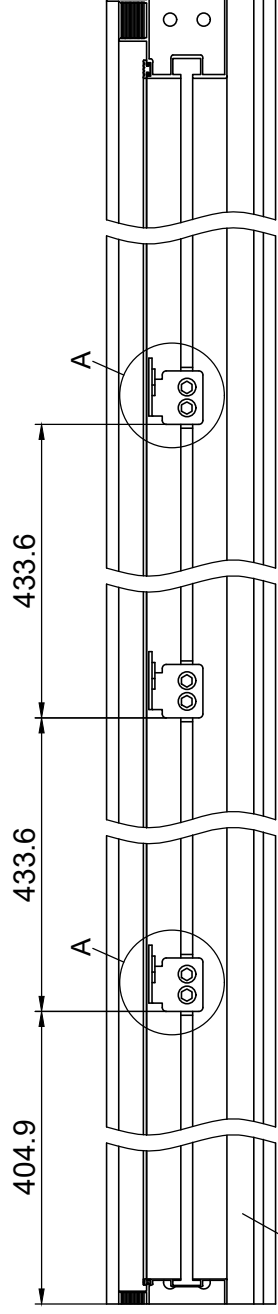

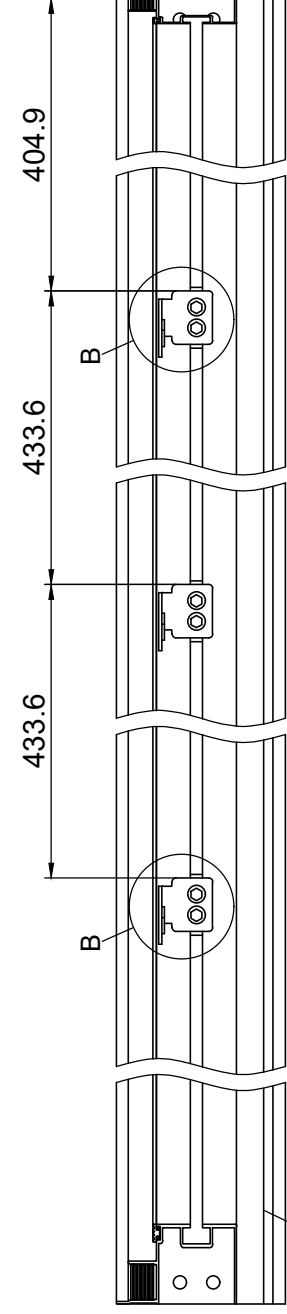
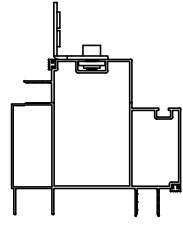
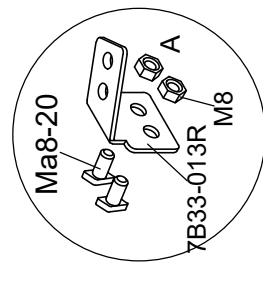

41X-Y21



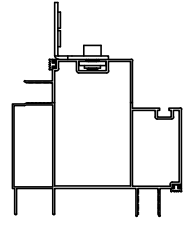
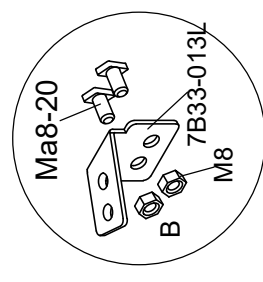





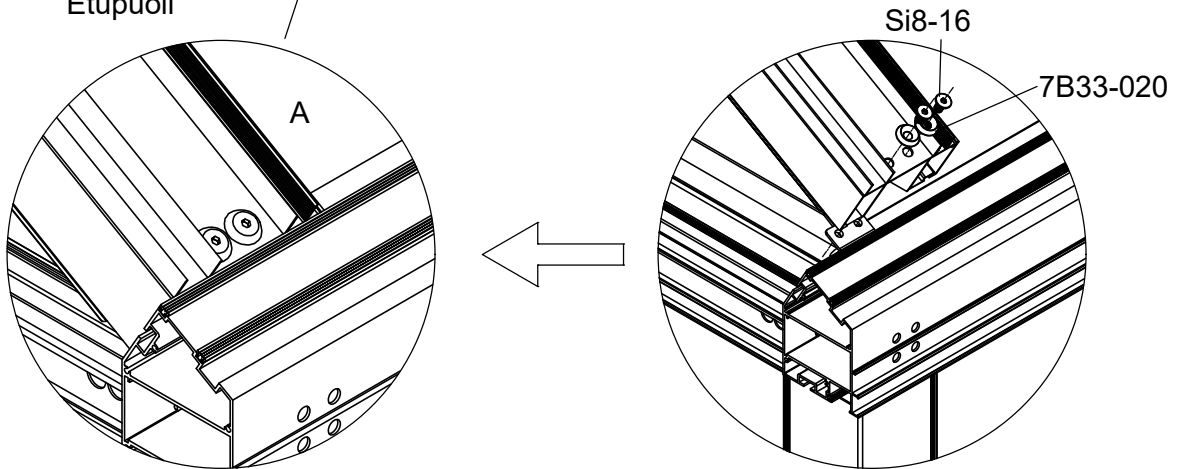
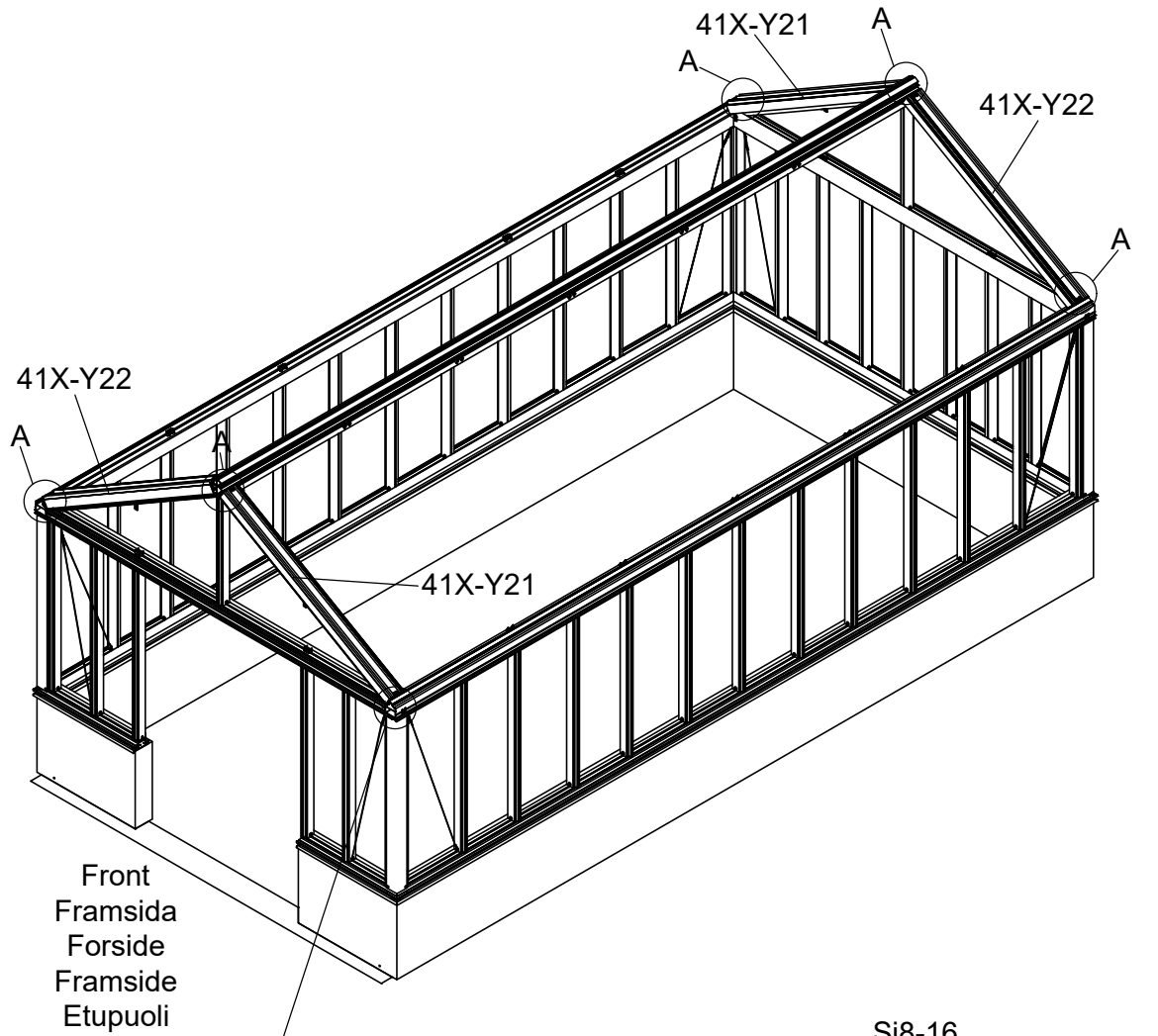



41X-Y22









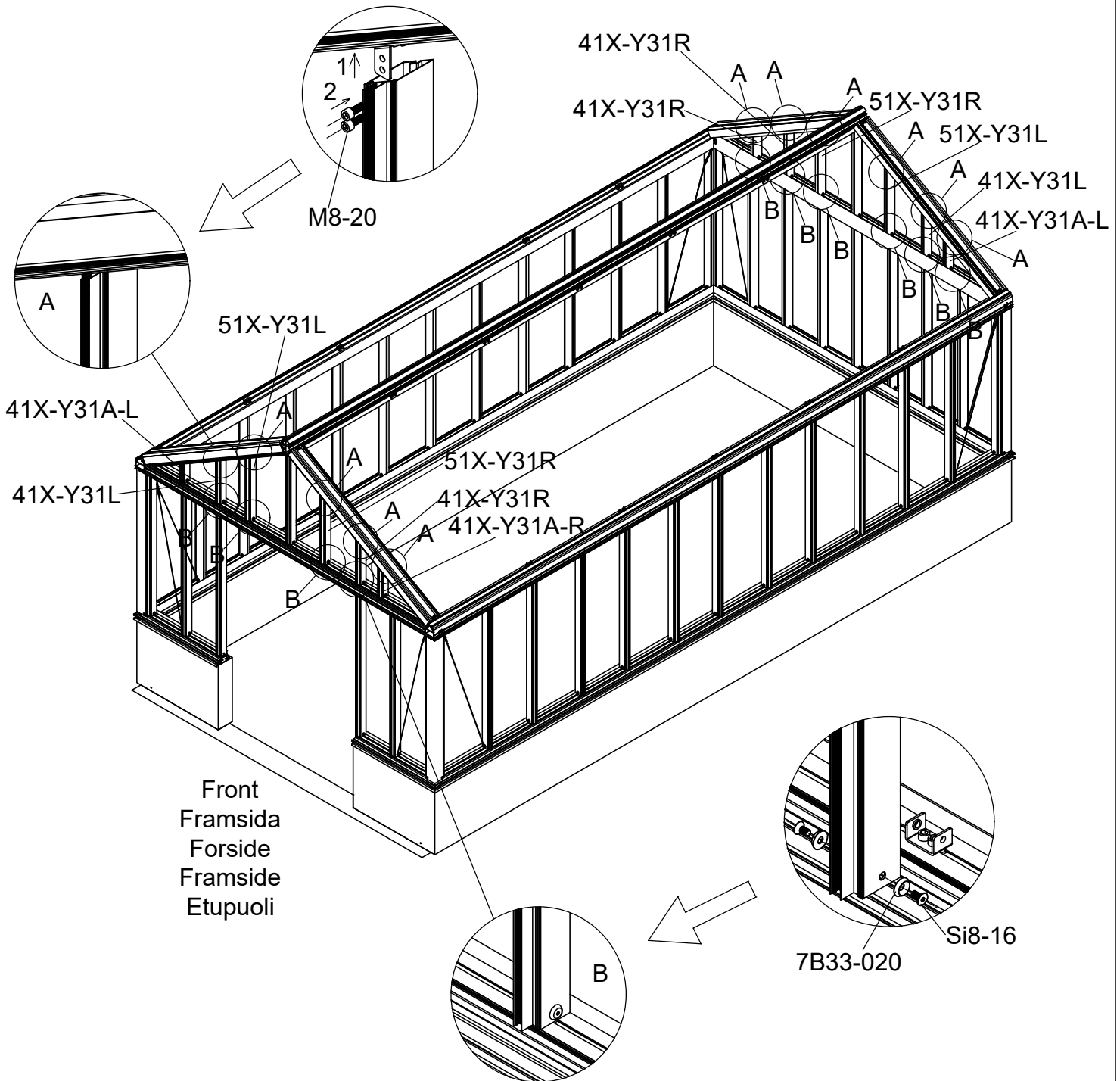

Part	NO.	QTY.	Length(MM)
	Si8-16	16	PCS
	7B33-020	16	PCS





Part	NO.	QTY.	Length(MM)
	41X-Y31R	2	412
	41X-Y31L	2	412
	M8-20	8	PCS
	Si8-16	8	PCS
	7B33-020	8	PCS

Part	NO.	QTY.	Length(MM)	CTN NO.
	41X-Y31A-R	2	196	SH2GA1-BSC-2
	41X-Y31A-L	2	196	SH2GA1-BSC-2
	51X-Y31L	2	629	SH2GA1-BSC-2
	51X-Y31R	2	629	SH2GA1-BSC-2
	M8-20	16	PCS	SH2GA1-BSC-2
	Si8-16	16	PCS	SH2GA1-BSC-2
	7B33-020	16	PCS	SH2GA1-BSC-2

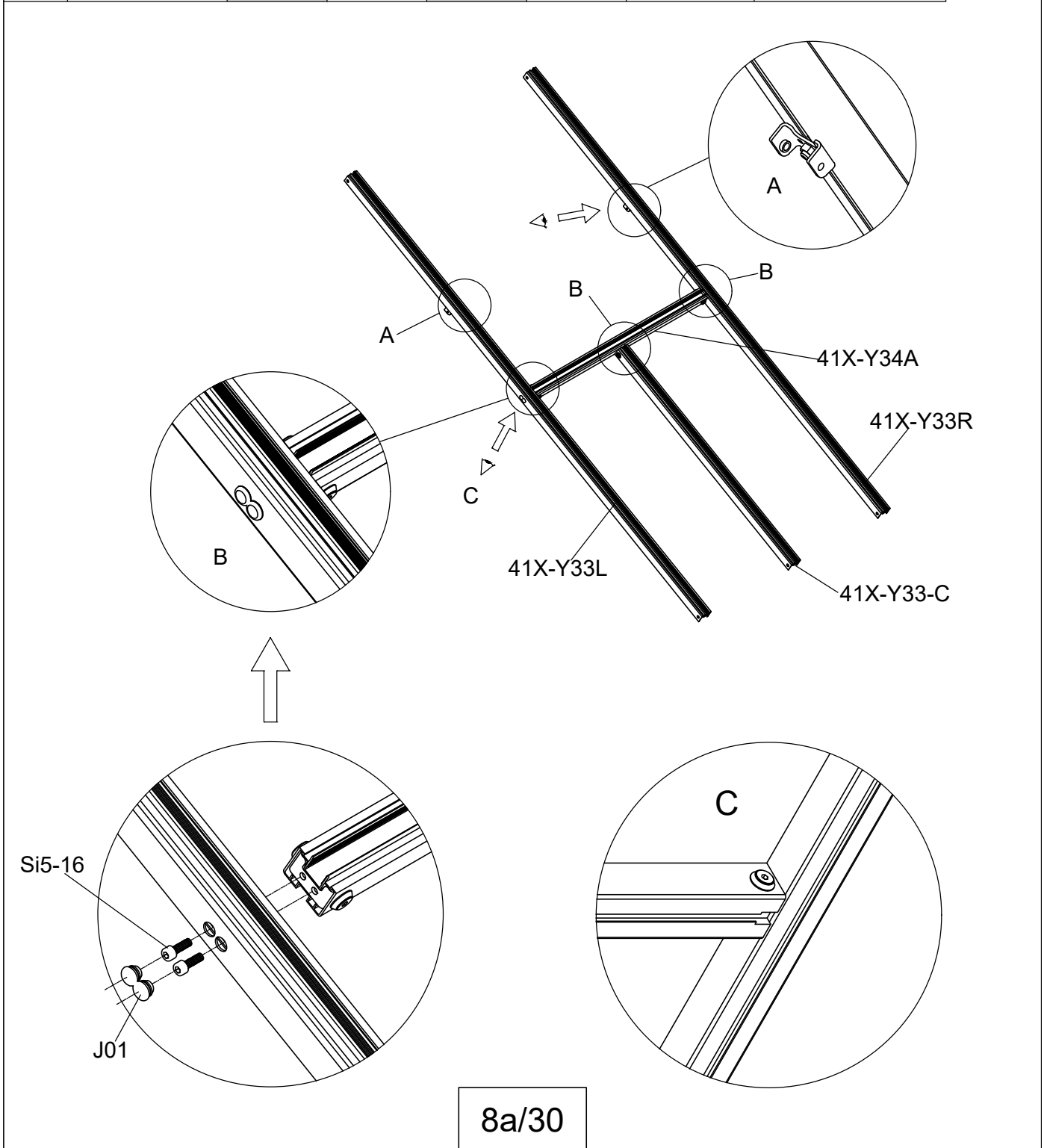

Part	NO.	QTY.				Length(MM)	CTN NO.
		3721	3722	3723	3724		
	41X-Y33R	2	2	4	4	1715	
	41X-Y33L	2	2	4	4	1715	
	41X-Y34A	2	2	4	4	951	SH2GA1-EXTW-2
	41X-Y33-C	2	2	4	4	833	SH2GA1-EXTW-2
	M8-20	8	8	16	16	PCS	
	M8-20	4	4	8	8	PCS	SH2GA1-EXTW-2
	7C33-001	8	8	16	16	PCS	
	7C33-001	4	4	8	8	PCS	SH2GA1-EXTW-2



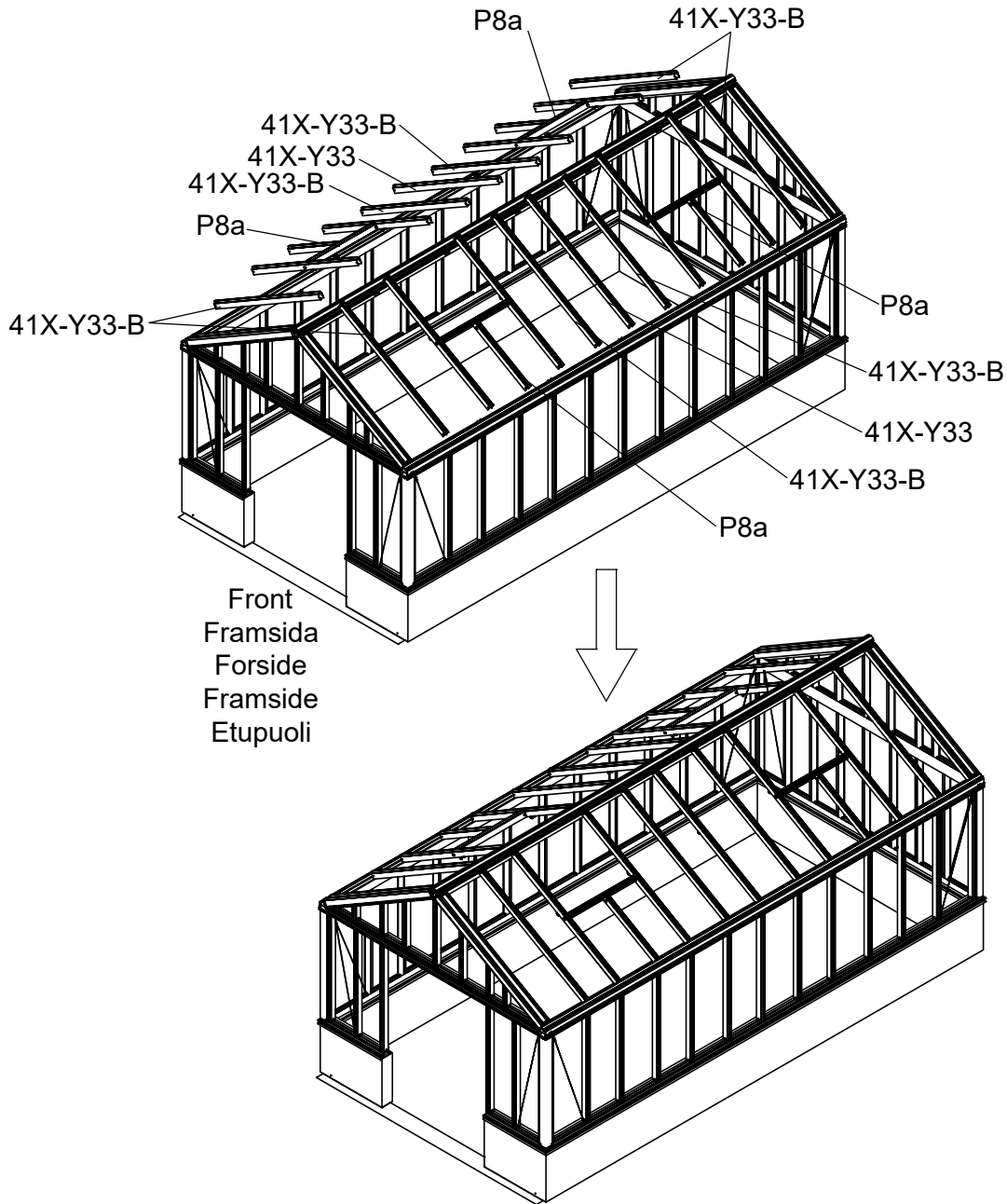

Part	NO.	QTY.				Length(MM)	CTN NO.
		3721	3722	3723	3724		
	41X-Y33	0	2	0	2	1715	
	41X-Y33-B	4	6	6	8	1715	SH2GA1-EXTN-2

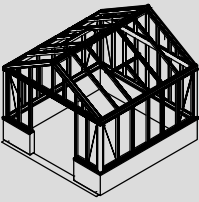
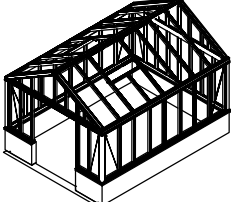
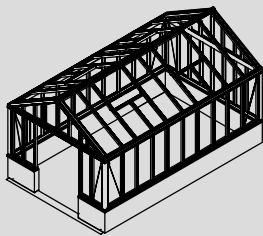
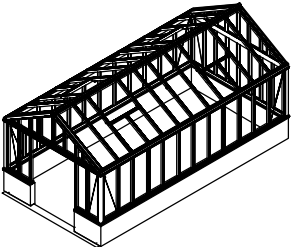

3721	3722	3723	3724
			

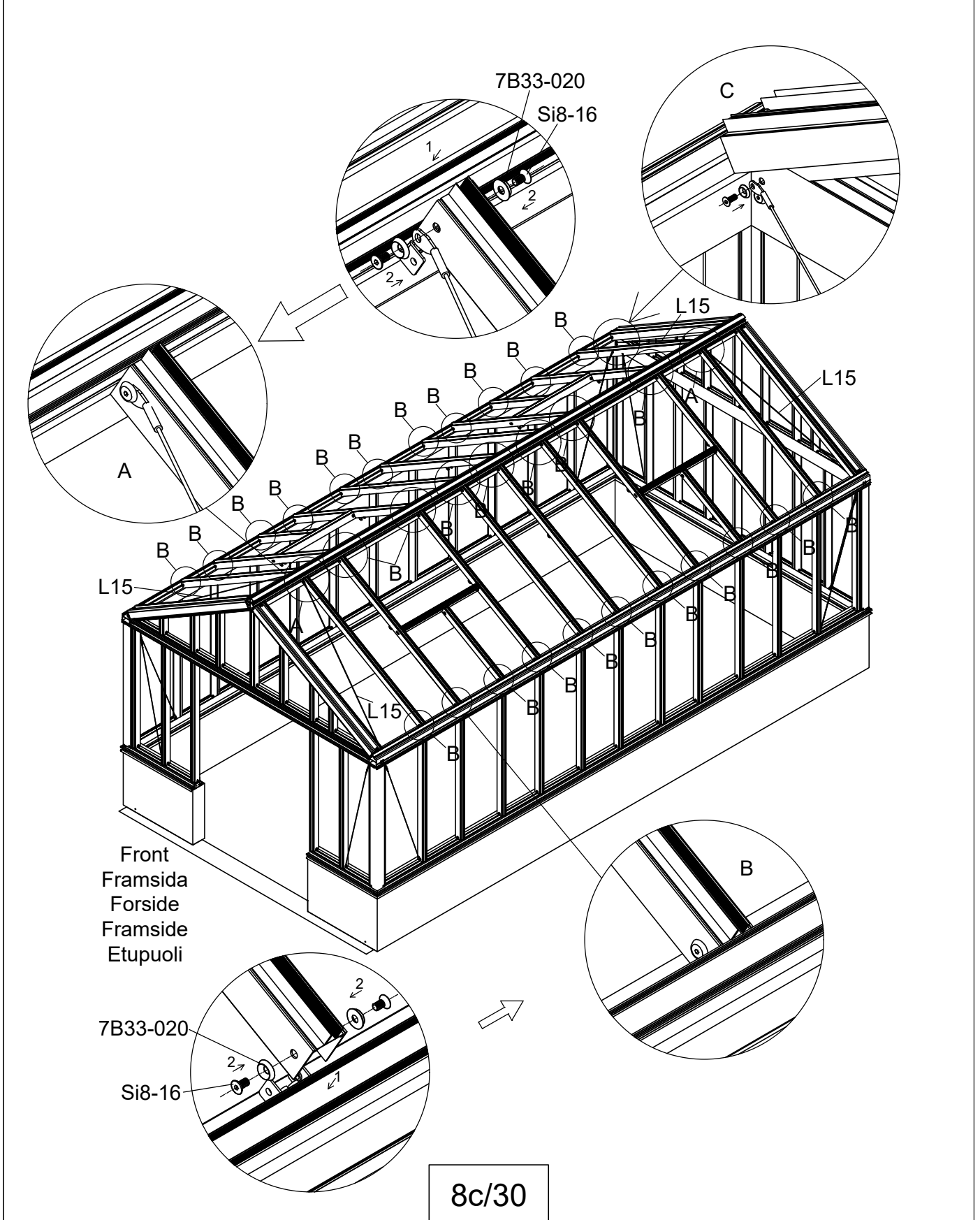
Part	NO.	QTY.											Length (MM)	
		3721			3722			3723			3724			
		3721	SH2GA1-EXTN-2	SH2GA1-EXTW-2	3722	SH2GA1-EXTN-2	SH2GA1-EXTW-2	3723	SH2GA1-EXTN-2	SH2GA1-EXTW-2	3724	SH2GA1-EXTN-2		SH2GA1-EXTW-2
	Si8-16	16	16	4	24	24	4	32	24	8	40	32	8	PCS
	7B33-020	16	16	4	24	24	4	32	24	8	40	32	8	PCS
	L15	4											1761	





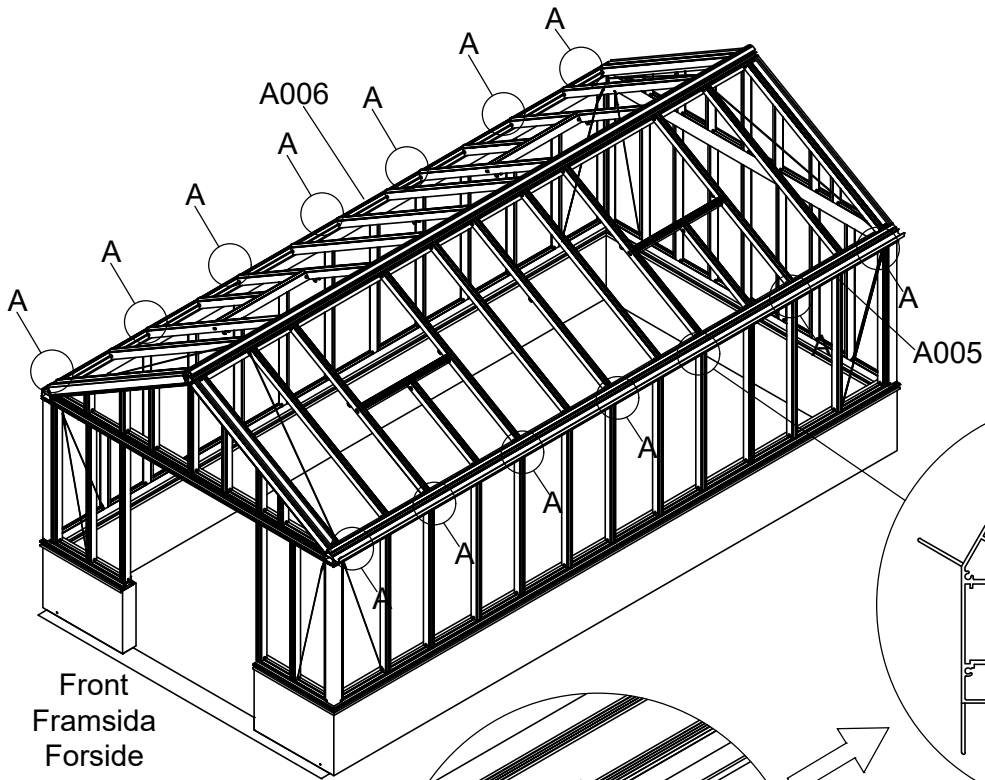

Part	NO.	QTY.				Length(MM)
		3721	3722	3723	3724	
	7C28-004	8	10	12	14	PCS
	Z4.2-13	16	20	24	28	PCS

Part	Product	NO.	Length(MM)	QTY.	Code
	3721	41X-Y62-3BR	3227	1	A005
	3722	41X-Y62-4BR	4228		
	3723	41X-Y62-5BR	5229		
	3724	41X-Y62-6BR	6230		
	3721	41X-Y62-3BL	3227	1	A006
	3722	41X-Y62-4BL	4228		
	3723	41X-Y62-5BL	5229		
	3724	41X-Y62-6BL	6230		

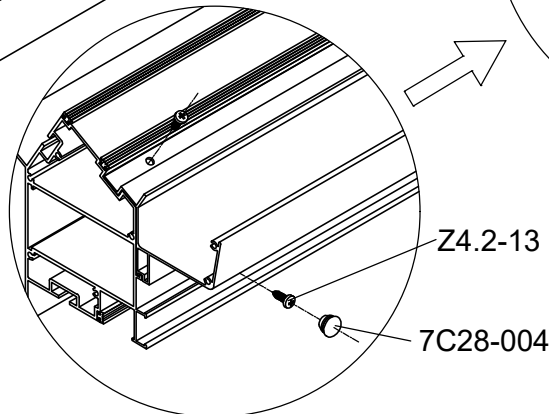

Front
Framsida
Forside
Framsida
Etupuoli



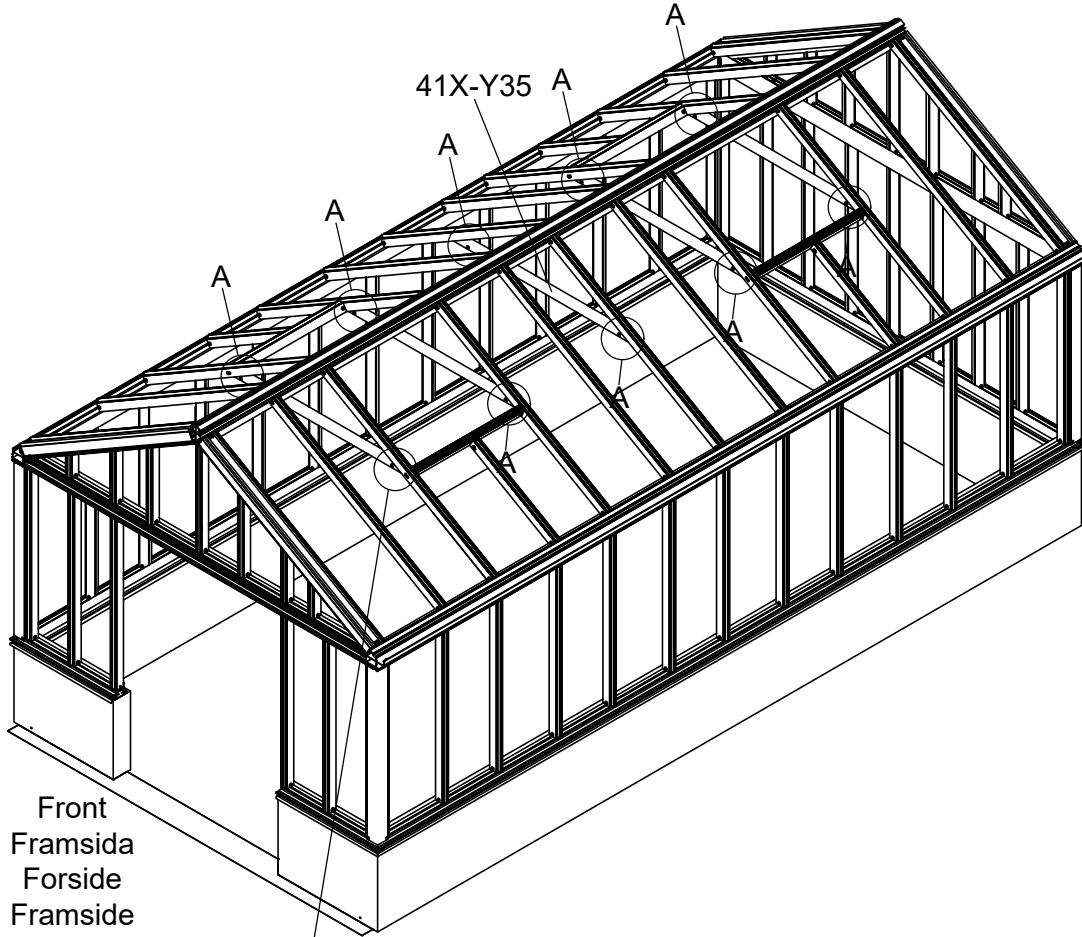

Part	NO.	QTY.				Length(MM)
		3721	3722	3723	3724	
	41X-Y35	2	3	4	5	1500
	Si8-16	8	12	16	20	PCS
	7B33-020	8	12	16	20	PCS

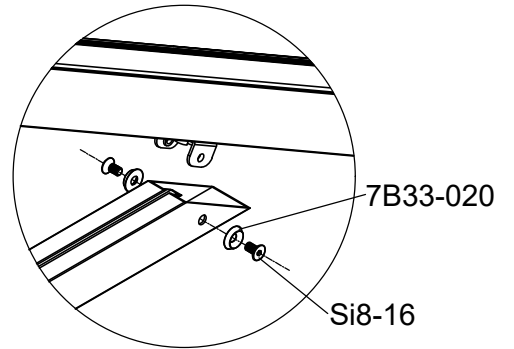
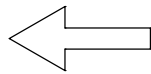
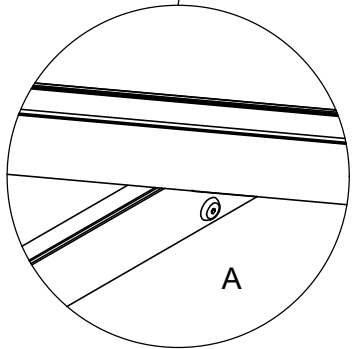

Front
Framsida
Forside
Framsida
Etu puoli

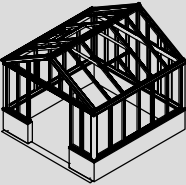
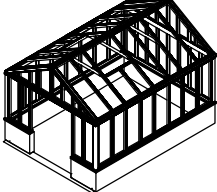
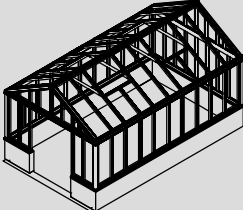
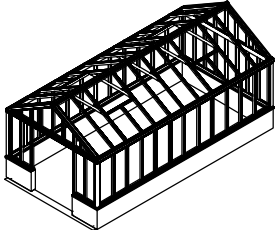

3721	3722	3723	3724
			

Part	NO.	QTY.																Length (MM)
		3721				3722				3723				3724				
		3721	SH2GA1-BSC-2	SH2GA1-EXTN-2	SH2GA1-EXTW-2	3722	SH2GA1-BSC-2	SH2GA1-EXTN-2	SH2GA1-EXTW-2	3723	SH2GA1-BSC-2	SH2GA1-EXTN-2	SH2GA1-EXTW-2	3724	SH2GA1-BSC-2	SH2GA1-EXTN-2	SH2GA1-EXTW-2	
	J12	36	18	12	6	42	18	18	6	48	18	18	12	54	18	24	12	PCS

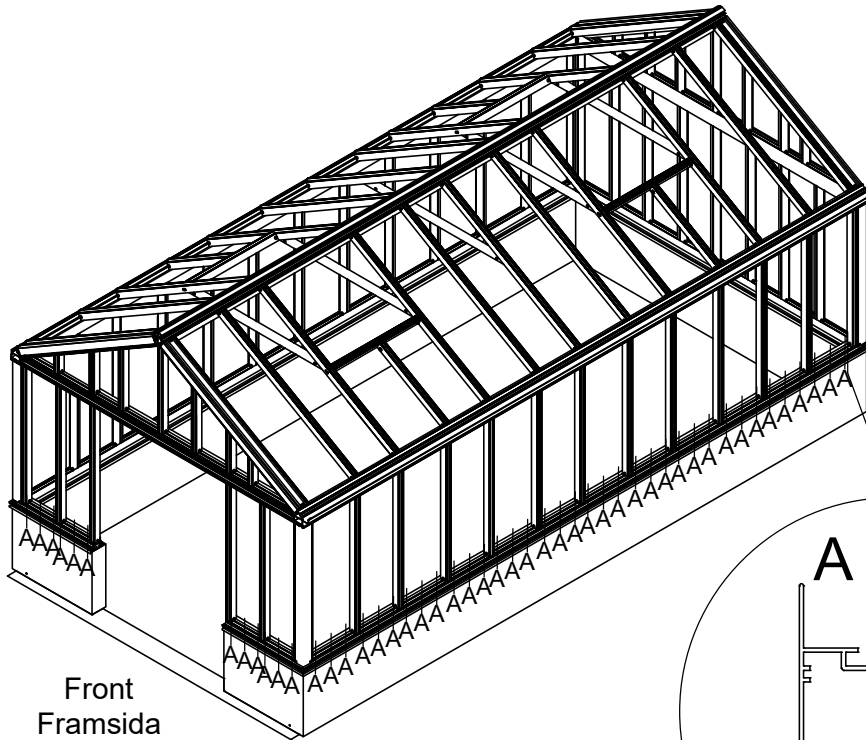

Front
Framsida
Forside
Framsida
Etupuoli

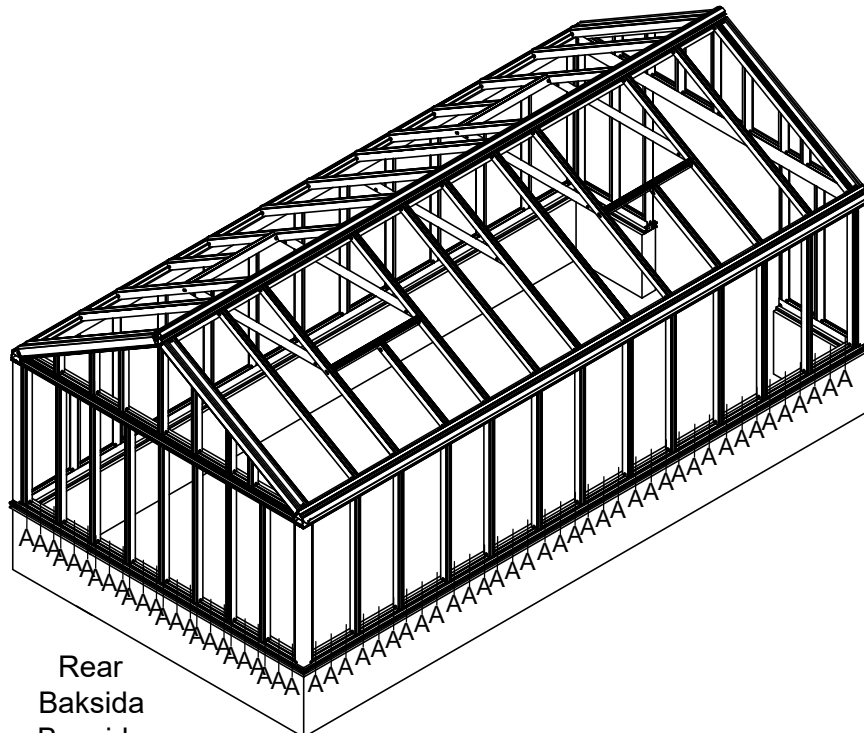
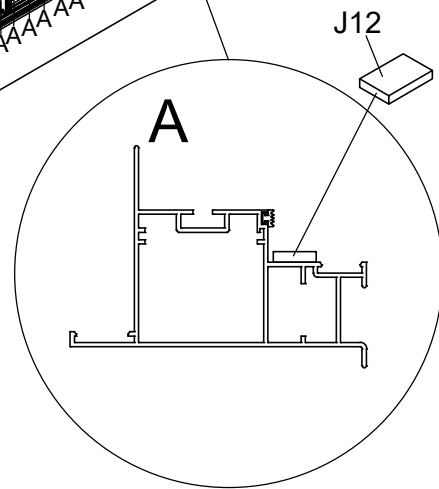

Rear
Baksida
Bagside
Baksida
Takapuoli

Part	NO.	QTY.				Length(MM)
		3721	3722	3723	3724	
<input type="checkbox"/>	354×1369	4	4	4	4	1369
<input type="checkbox"/>	479×1369	6	8	10	12	1369

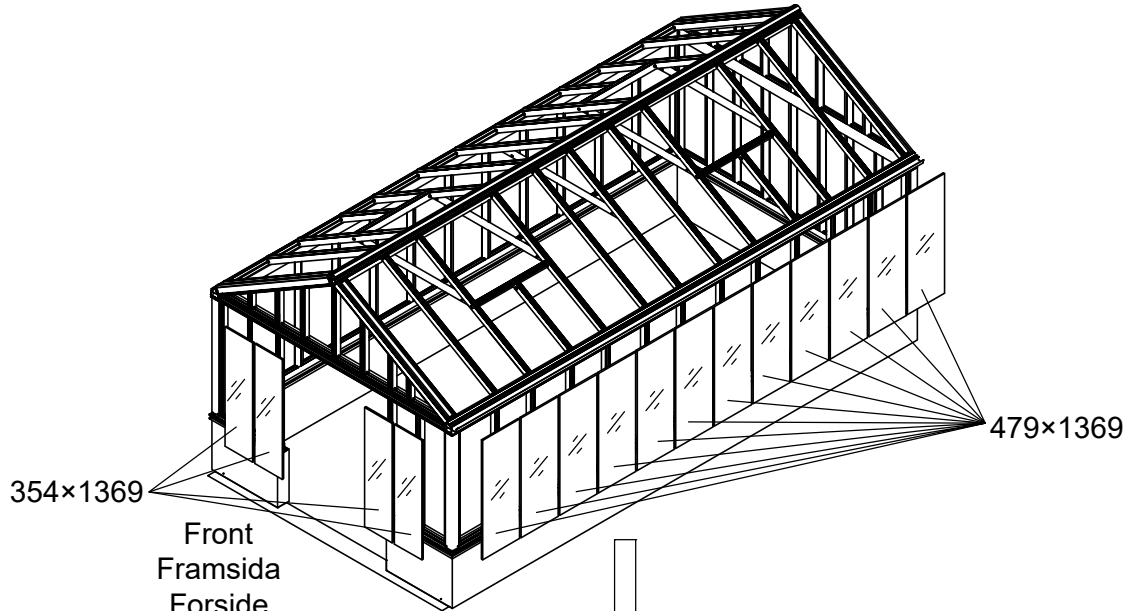

Front
Framsida
Forside
Framsida
Etuipuoli

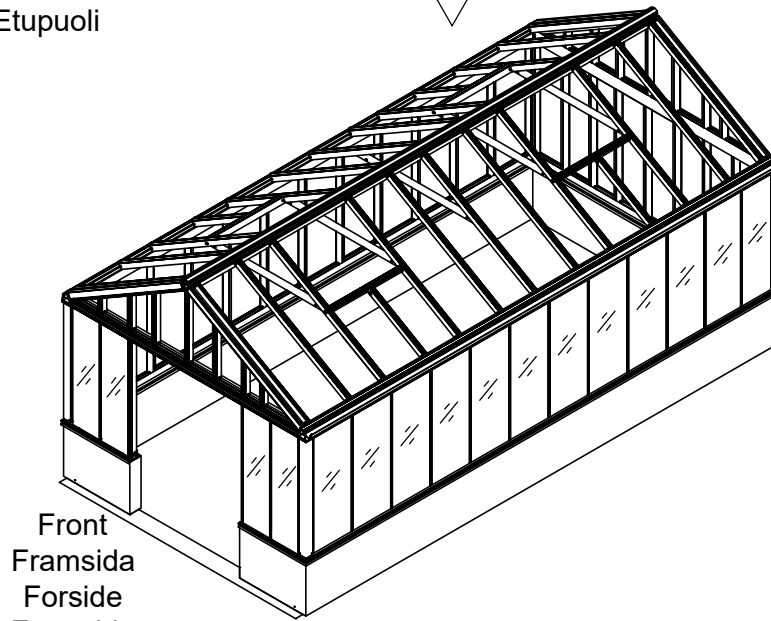



Front
Framsida
Forside
Framsida
Etuipuoli

3721	3722	3723	3724

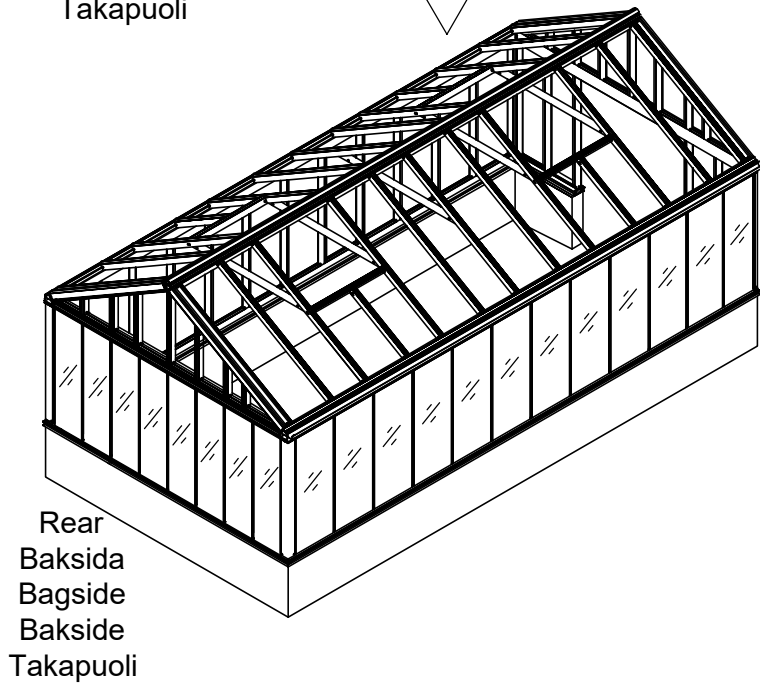
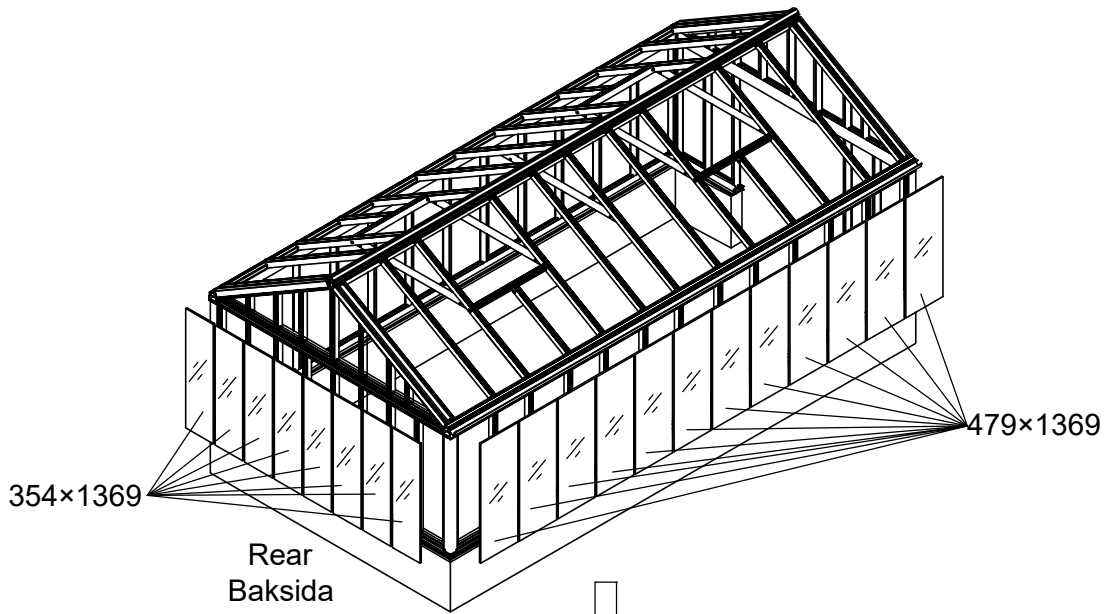
Part	NO.	QTY.				Length(MM)
		3721	3722	3723	3724	
<input type="checkbox"/>	354×1369	6	6	6	6	1369
<input type="checkbox"/>	479×1369	6	8	10	12	1369



3721	3722	3723	SH2GA1D-2

Part	NO.	QTY.	Length(MM)
	41A-Y14L	1	894
	41A-Y14R	1	894
	41X-Y14	1	3239

Part	Product	NO.	Length(MM)	QTY.	Code
	3721	41X-Y15-3	3238	2	A007
	3722	41X-Y15-4	4239		
	3723	41X-Y15-5	5240		
	3724	41X-Y15-6	6241		

41A-Y14L

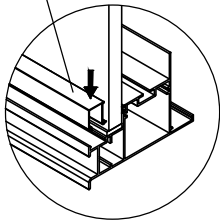

J12

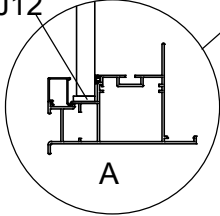

A

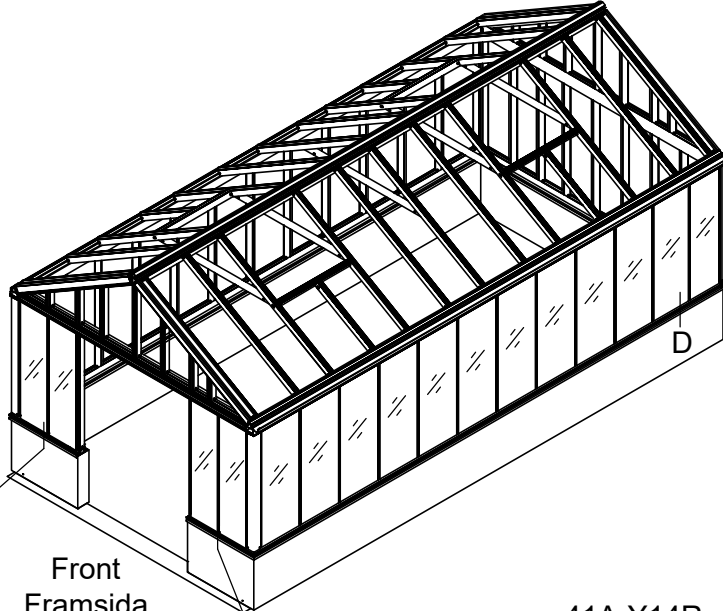

Front
Framsida
Forside
Framsida
Etu puoli

J12

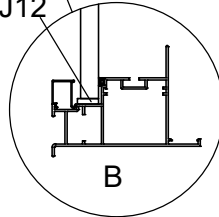

B

41A-Y14R

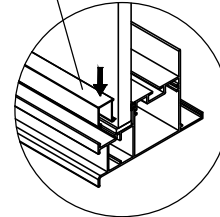

41A-Y14

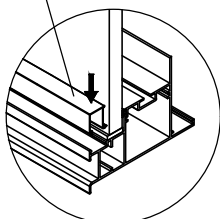

J12

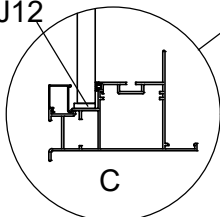

C

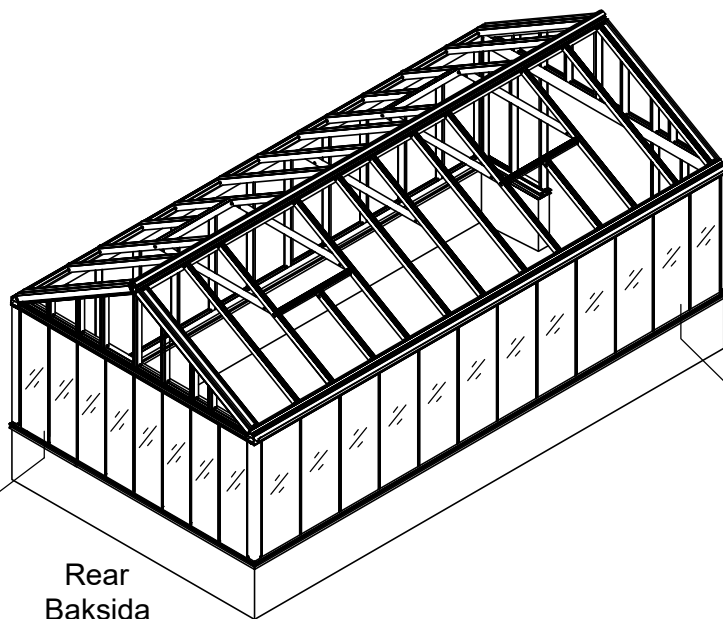

Rear
Baksida
Bagside
Baksida
Takapuoli

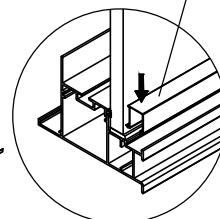

41A-Y15-6

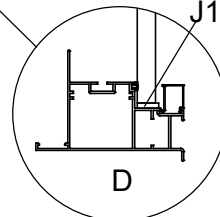

J12



D

Part	NO.	QTY.																Length (MM)
		3721				3722				3723				3724				
		3721	SH2GA1-BSC-2	SH2GA1-EXTN-2	SH2GA1-EXTW-2	3722	SH2GA1-BSC-2	SH2GA1-EXTN-2	SH2GA1-EXTW-2	3723	SH2GA1-BSC-2	SH2GA1-EXTN-2	SH2GA1-EXTW-2	3724	SH2GA1-BSC-2	SH2GA1-EXTN-2	SH2GA1-EXTW-2	
	41X-Y01	4	2	2	1	5	2	3	1	6	2	3	2	7	2	4	2	1335
	41X-Y02	4																1335

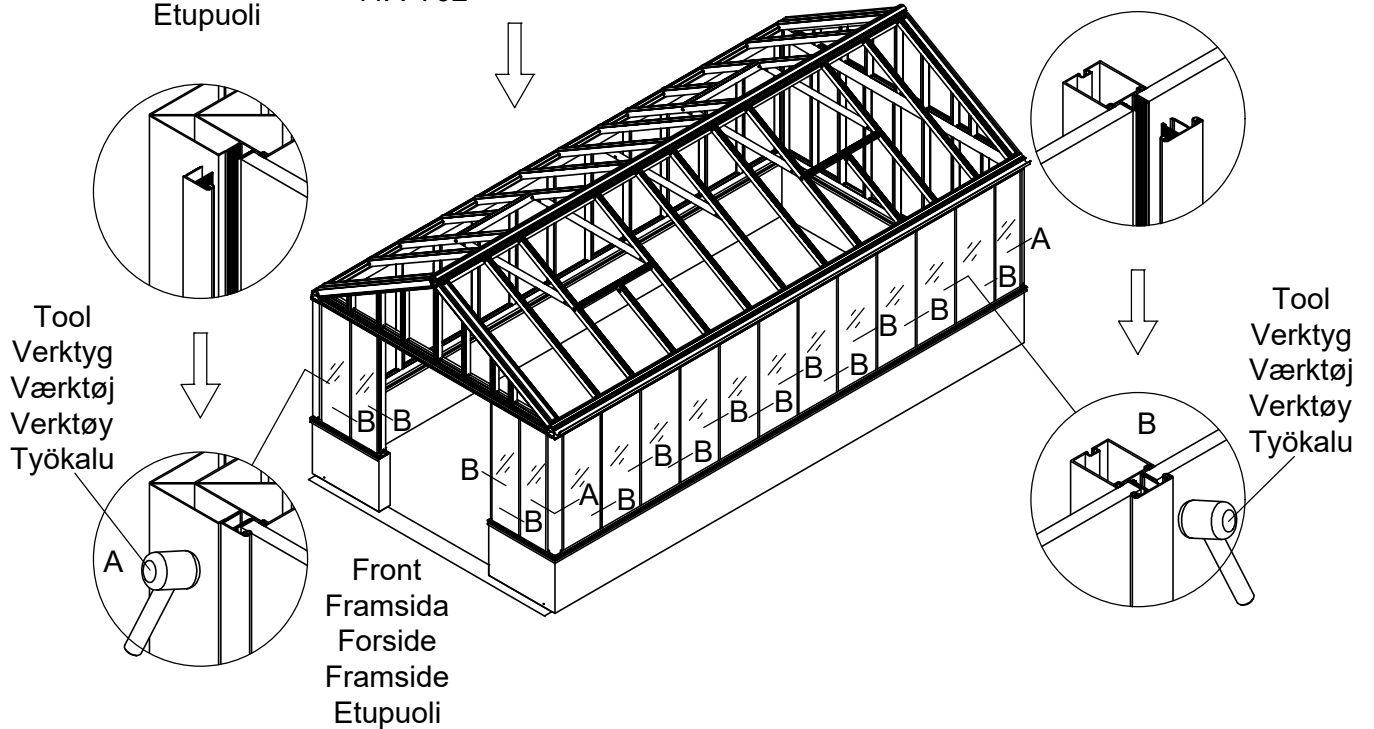
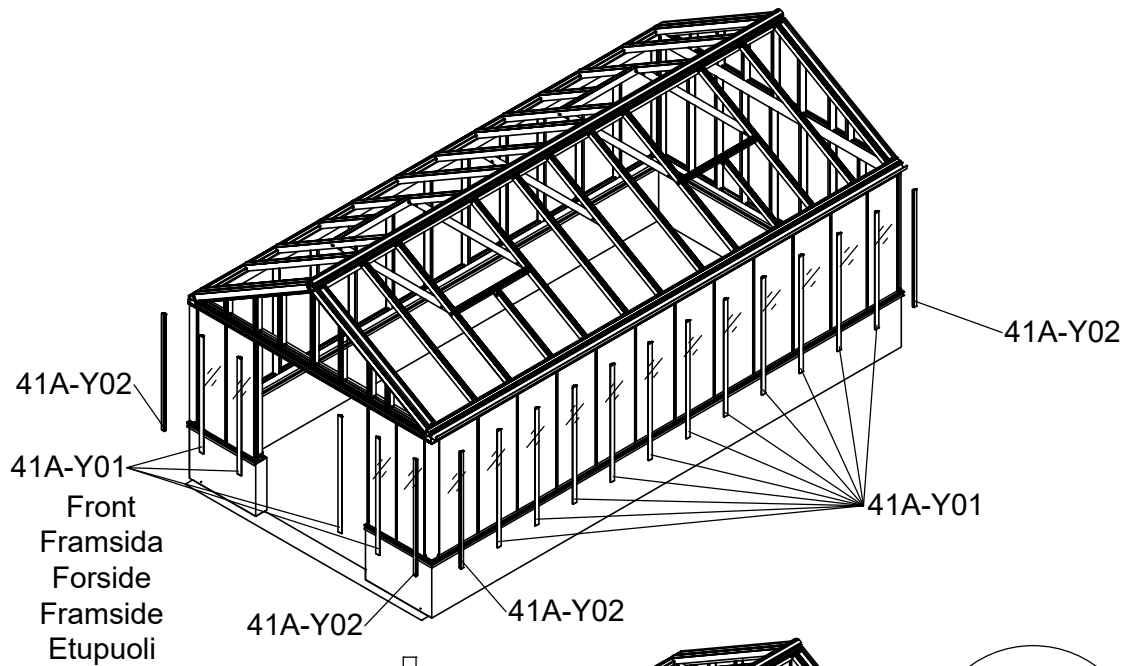

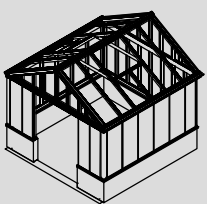
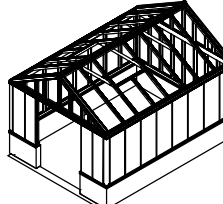
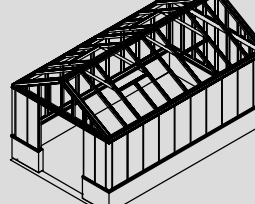
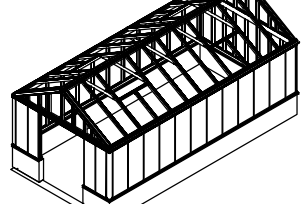
3721	3722	3723	3724
			

Part	NO.	QTY.																Length (MM)
		3721				3722				3723				3724				
		3721	SH2GA1- BSC-2	SH2GA1- EXTN-2	SH2GA1- EXTW-2	3722	SH2GA1- BSC-2	SH2GA1- EXTN-2	SH2GA1- EXTW-2	3723	SH2GA1- BSC-2	SH2GA1- EXTN-2	SH2GA1- EXTW-2	3724	SH2GA1- BSC-2	SH2GA1- EXTN-2	SH2GA1- EXTW-2	
	41X-Y01	5	4	2	1	6	4	3	1	7	4	3	2	8	4	4	2	1335
	41X-Y02	4																1335

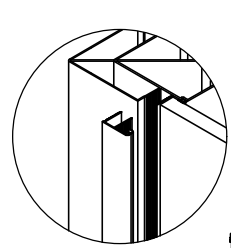
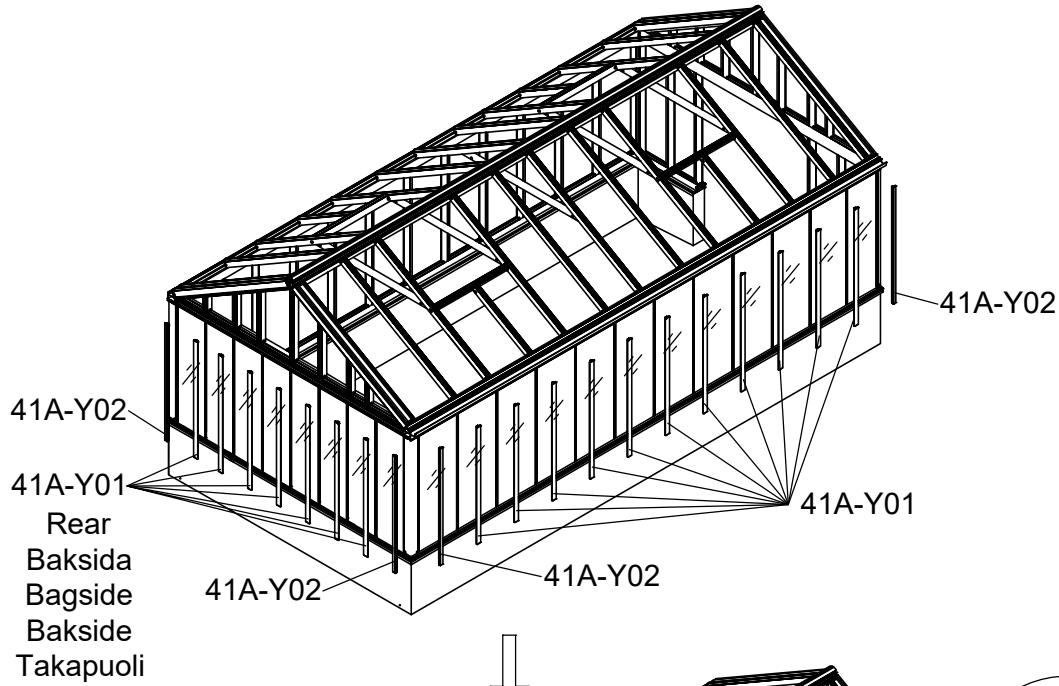

Tool
Verktøy
Værktøj
Verktøy
Työkälu

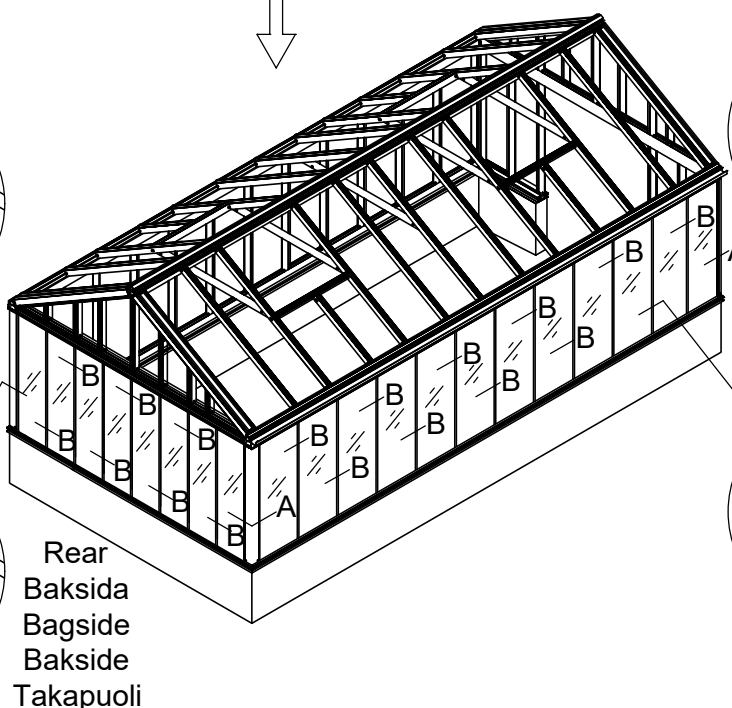
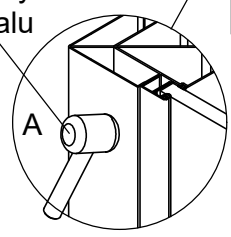

Rear
Baksida
Bagside
Bakside
Takapuoli

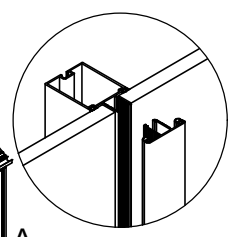

Tool
Verktøy
Værktøj
Verktøy
Työkälu

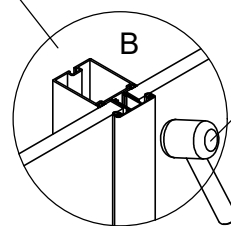

3721	3722	3723	3724

Part	NO.	QTY.				Length(MM)
		3721	3722	3723	3724	
	7C26-007N	21	25	29	33	PCS

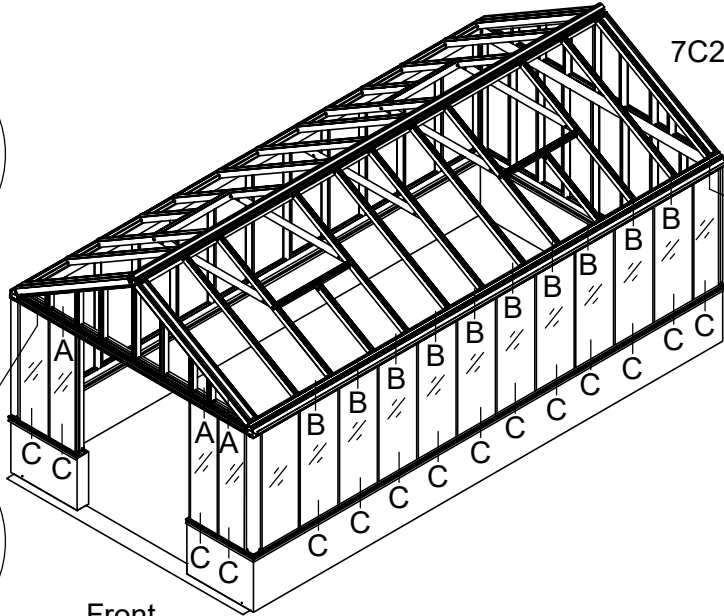
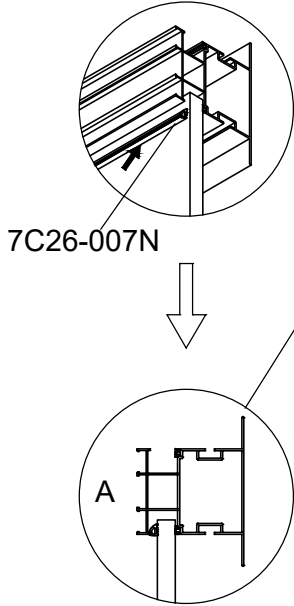

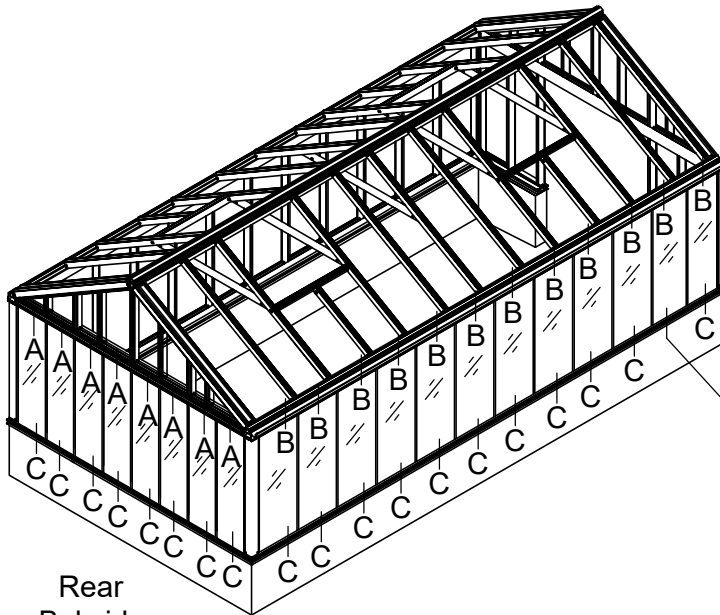
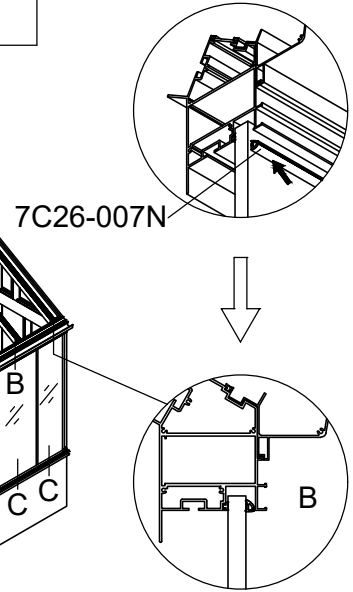

Front
Fransida
Forside
Franside
Etupuoli

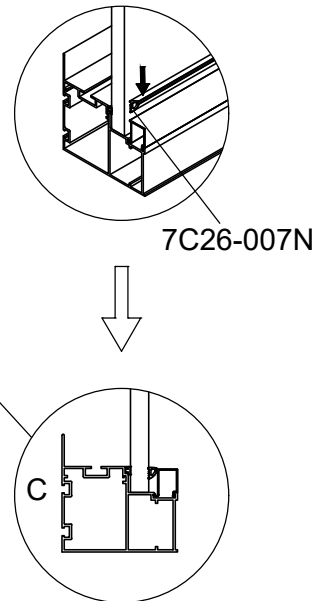

Rear
Baksida
Bagside
Baksida
Takapuoli





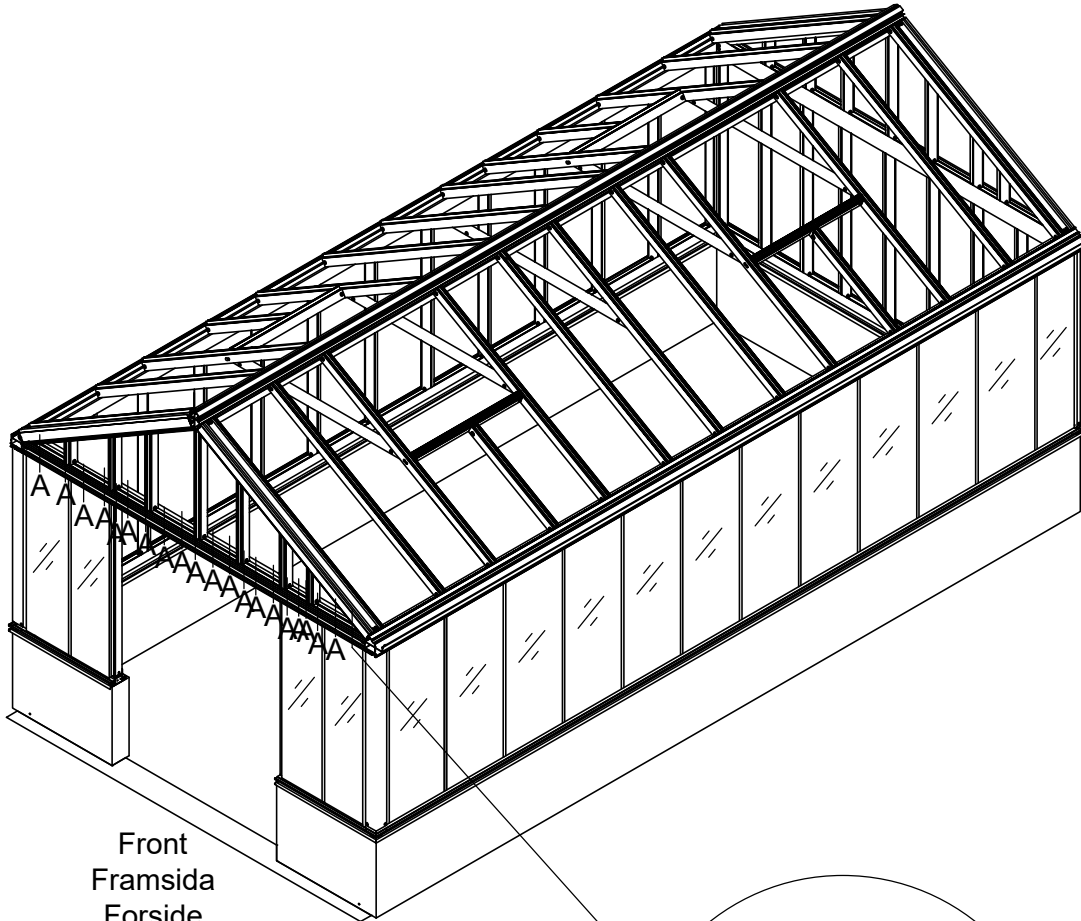

Part	NO.	QTY.	Length(MM)	
	J12	12	PCS	
	J12	12	PCS	SH2GA1-BSC-2

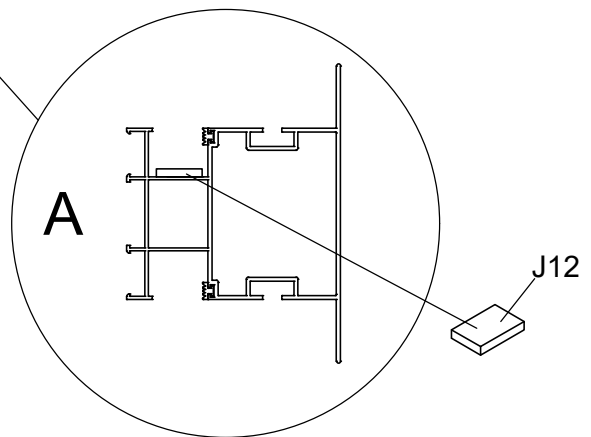





Front
 Framsida
 Forside
 Framside
 Etupuoli

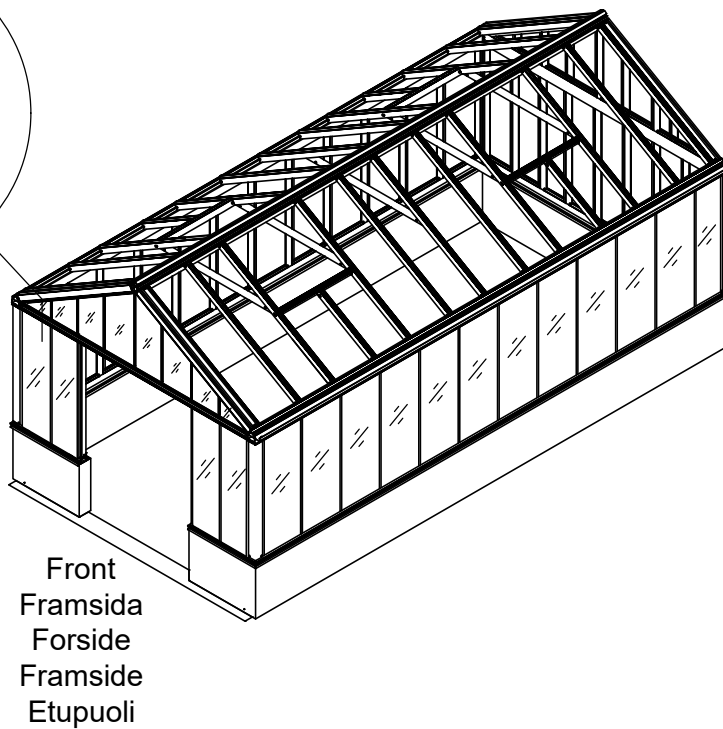
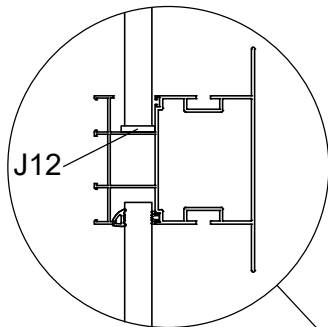
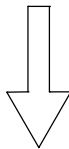
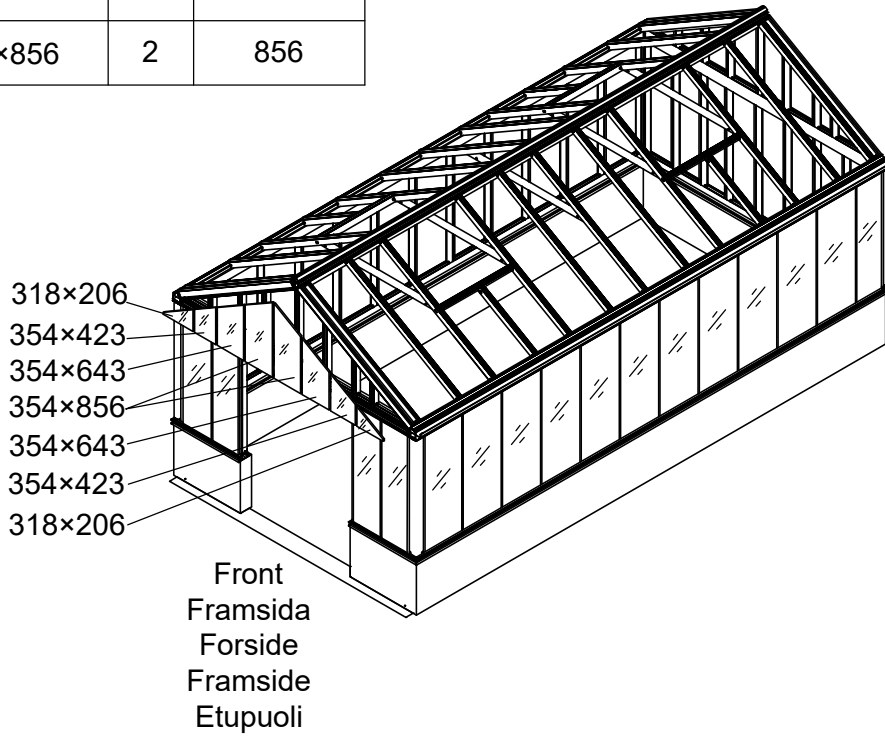

Part	NO.	QTY.	Length(MM)
	318×206	2	318
	354×423	2	423
	354×643	2	643
	354×856	2	856



Part	NO.	QTY.	Length(MM)
	41X-Y03	1	857
	41X-Y04R	1	412
	41X-Y04L	1	412
	41X-Y05R	1	1712
	41X-Y05L	1	1712

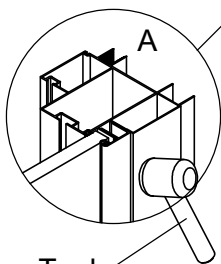
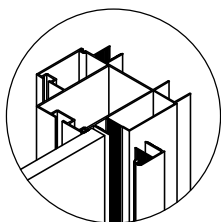
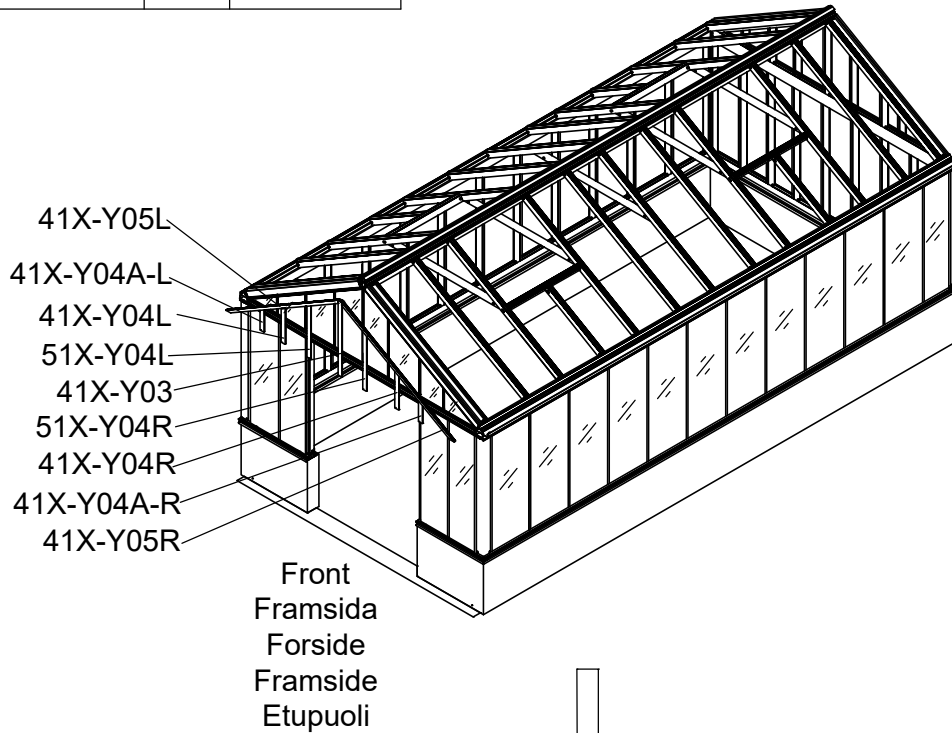

Part	NO.	QTY.	Length(MM)	CTN NO.
	41X-Y04A-R	1	196	SH2GA1-BSC-2
	41X-Y04A-L	1	196	SH2GA1-BSC-2
	51X-Y04R	1	629	SH2GA1-BSC-2
	51X-Y04L	1	629	SH2GA1-BSC-2

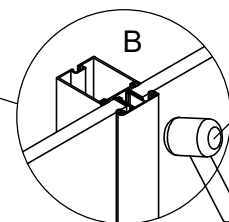
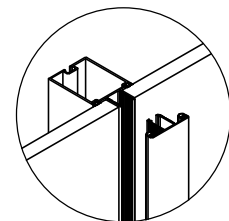
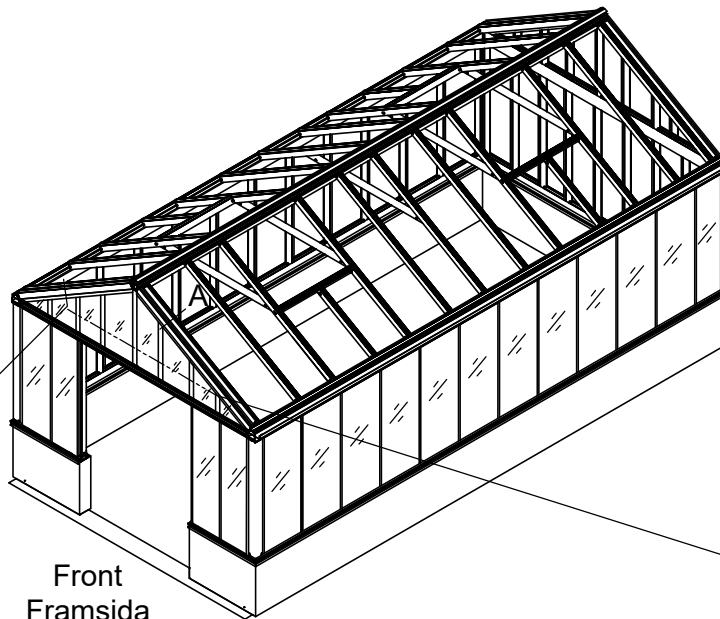

Tool
Verktøj
Værktøj
Verktøy
Työkalu





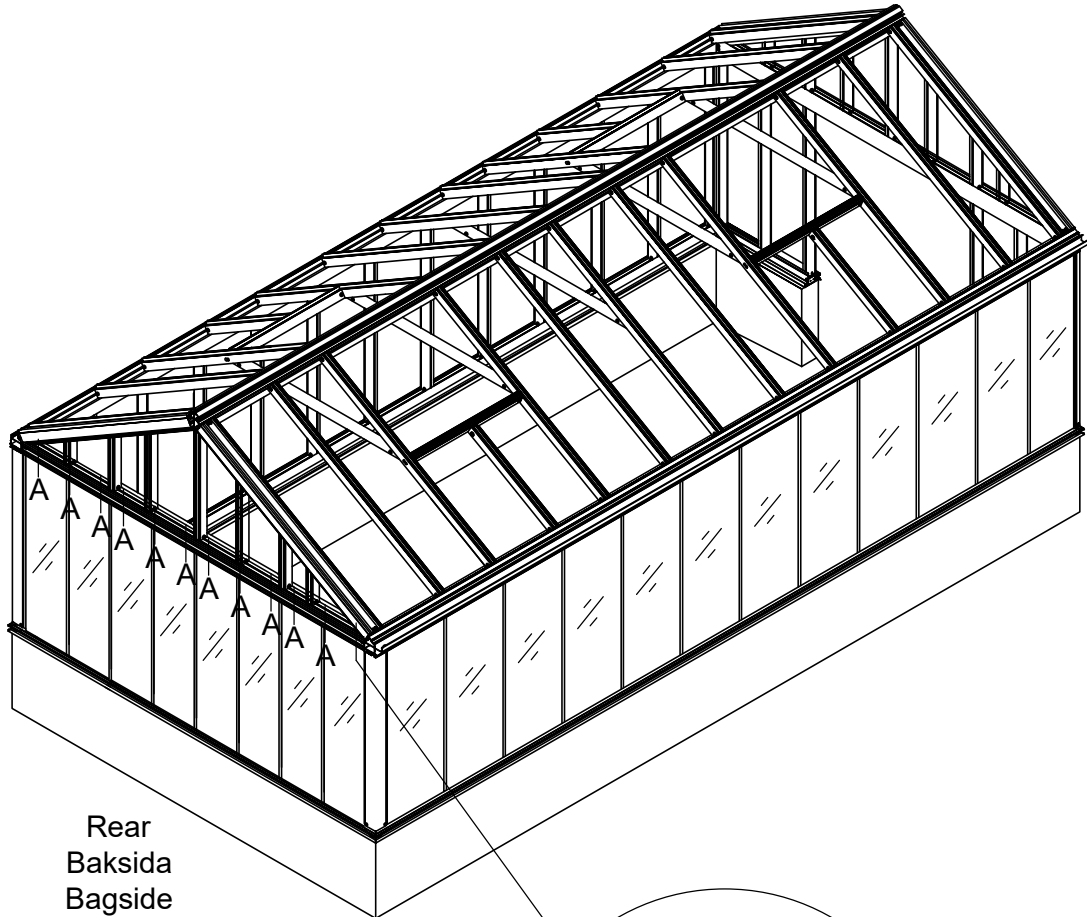

Tool
Verktøj
Værktøj
Verktøy
Työkalu

Part	NO.	QTY.	Length(MM)	
	J12	12	PCS	
	J12	12	PCS	SH2GA1-BSC-2

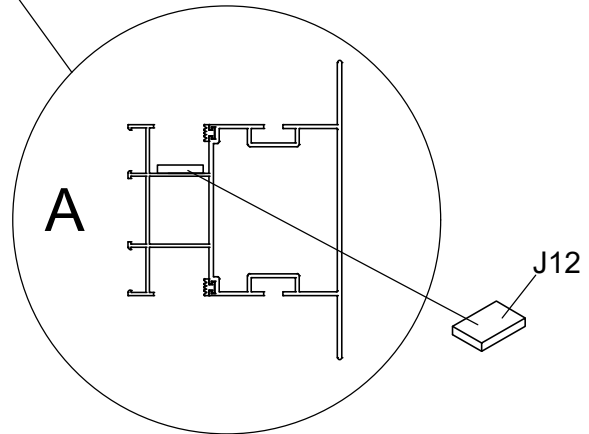

Rear
Baksida
Bagside
Baksida
Takapuoli



Part	NO.	QTY.	Length(MM)
	318×206	2	318
	354×423	2	423
	354×643	2	643
	354×856	2	856

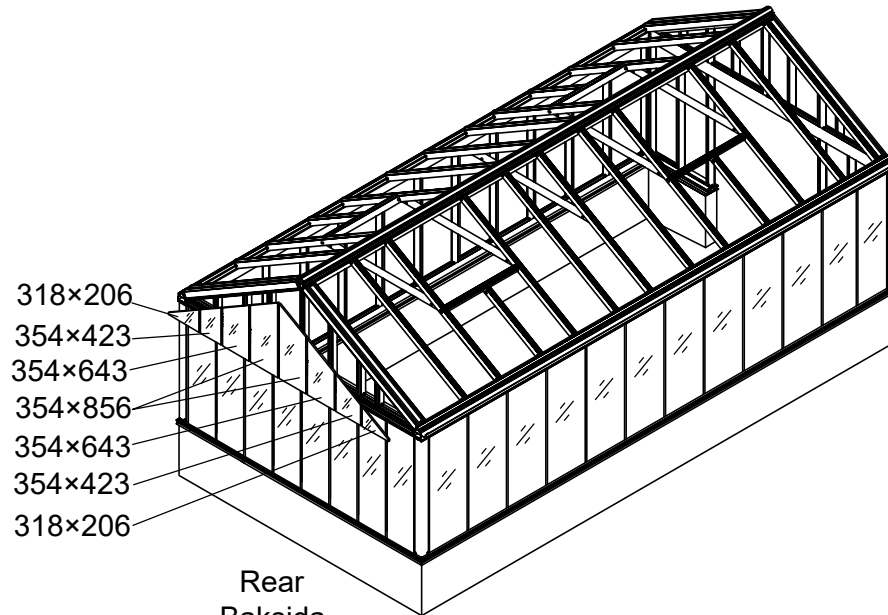



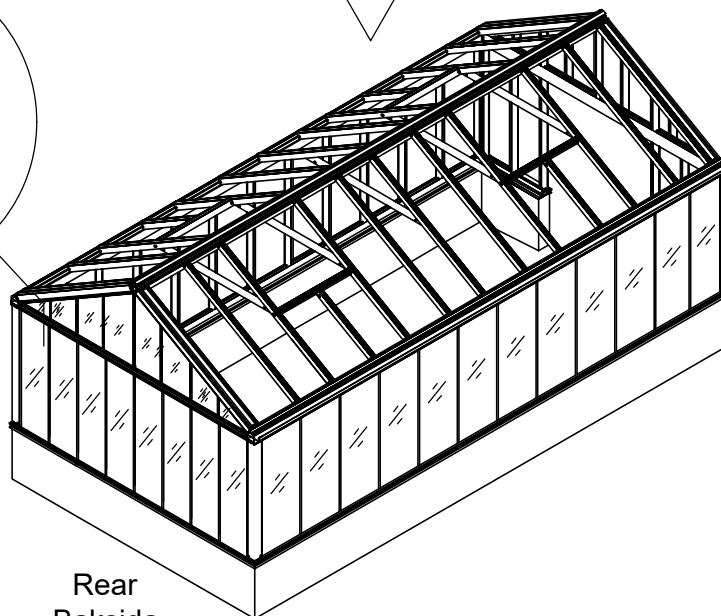
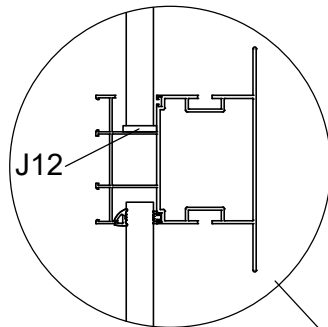
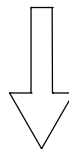

Rear
Baksida
Bagside
Baksida
Takapuoli



Rear
Baksida
Bagside
Baksida
Takapuoli

Part	NO.	QTY.	Length(MM)
	41X-Y03	1	857
	41X-Y04R	1	412
	41X-Y04L	1	412
	41X-Y05R	1	1712
	41X-Y05L	1	1712

Part	NO.	QTY.	Length(MM)	CTN NO.
	41X-Y04A-R	1	196	SH2GA1-BSC-2
	41X-Y04A-L	1	196	SH2GA1-BSC-2
	51X-Y04R	1	629	SH2GA1-BSC-2
	51X-Y04L	1	629	SH2GA1-BSC-2

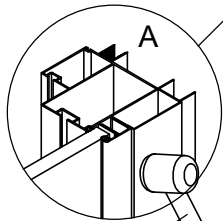
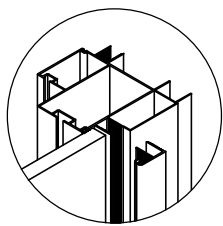
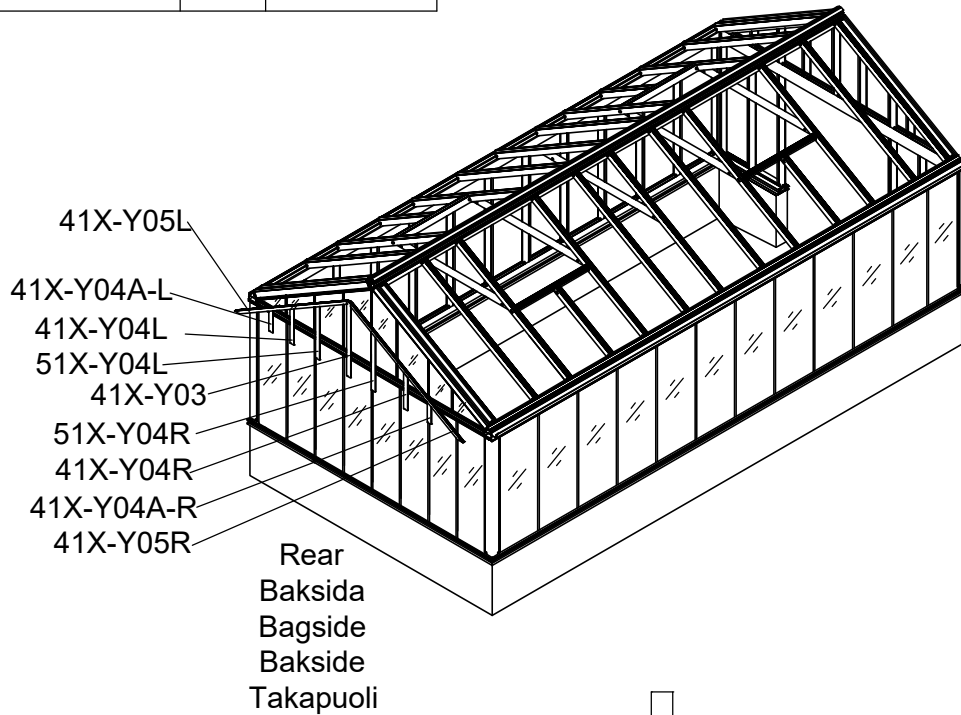

Tool
Verktøj
Værktøj
Verktøy
Työkälu

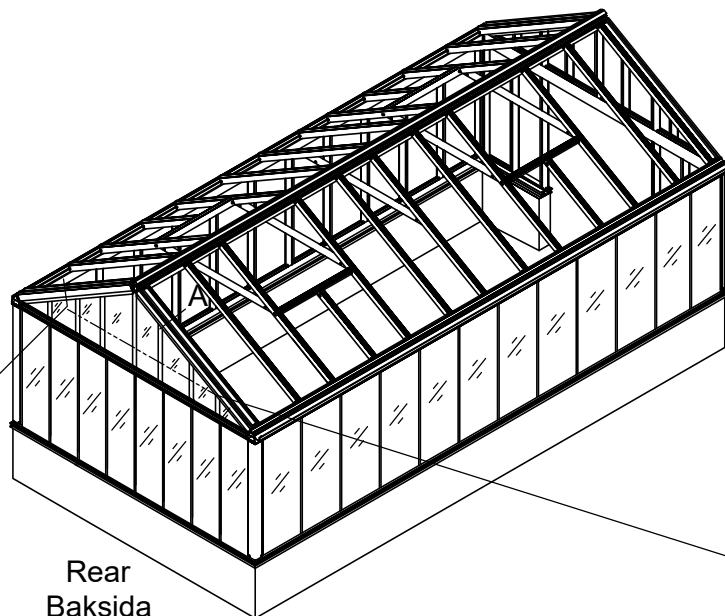

Rear
Baksida
Bagside
Bakside
Takapuoli

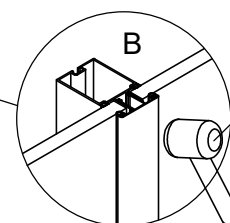
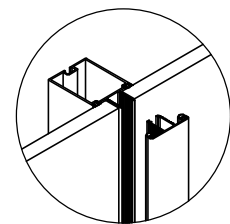

Tool
Verktøj
Værktøj
Verktøy
Työkälu

Part	NO.	QTY.	Length(MM)
	7C26-007N	6M	

7C26-007N

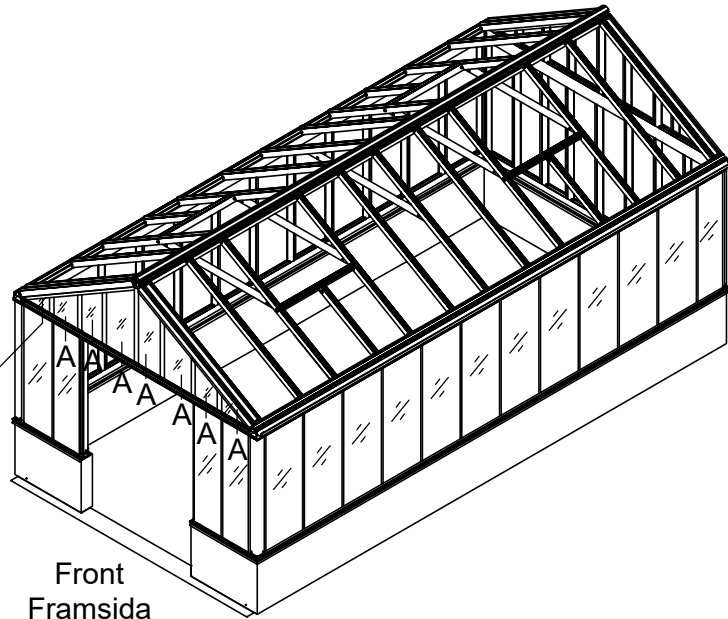
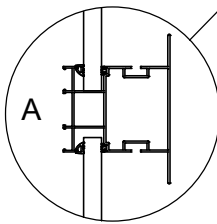
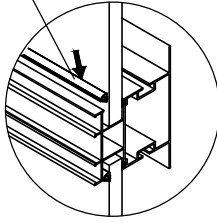

Front
Framsida
Forside
Framsida
Etupuoli

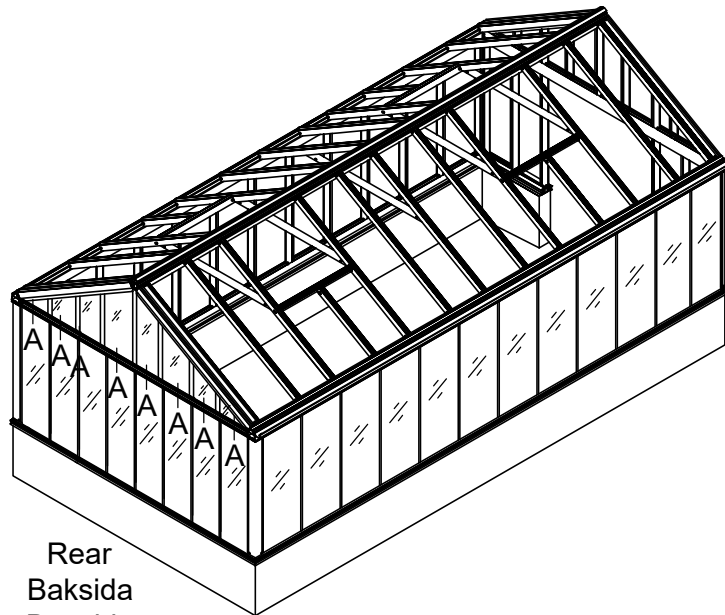

Rear
Baksida
Bagside
Baksida
Takapuoli

Part	NO.	QTY.											Length (MM)	
		3721			3722			3723			3724			
		3721	SH2GA1-EXTN-2	SH2GA1-EXTW-2	3722	SH2GA1-EXTN-2	SH2GA1-EXTW-2	3723	SH2GA1-EXTN-2	SH2GA1-EXTW-2	3724	SH2GA1-EXTN-2		SH2GA1-EXTW-2
	J12	18	12	6	24	18	6	30	18	12	36	24	12	PCS

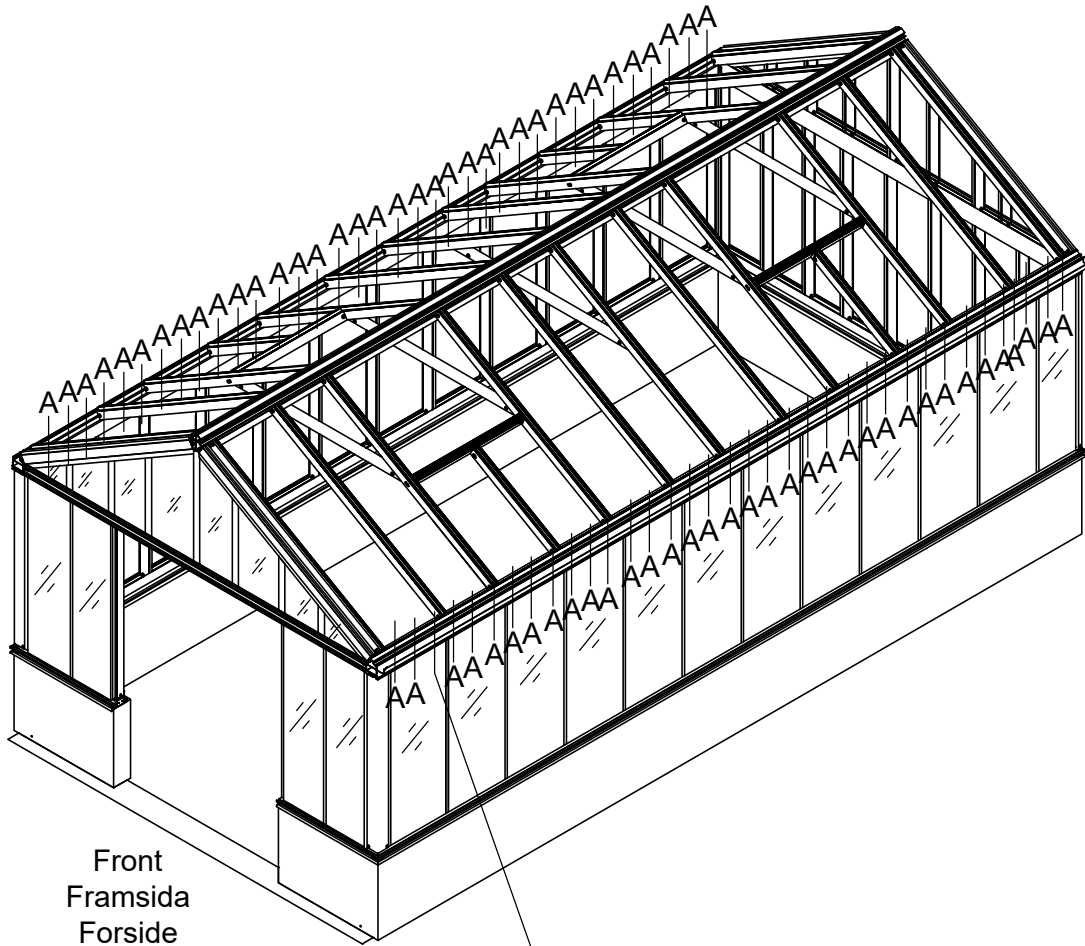

Front
Framsida
Forside
Framsida
Etupuoli

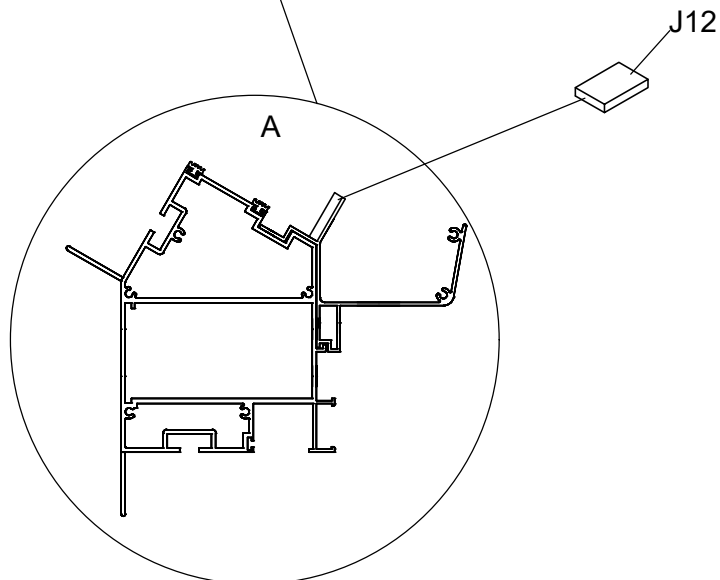

Part	NO.	QTY.				Length(MM)
		3721	3722	3723	3724	
	479×1800	8	12	12	16	1800
	479×909	4	4	8	8	909

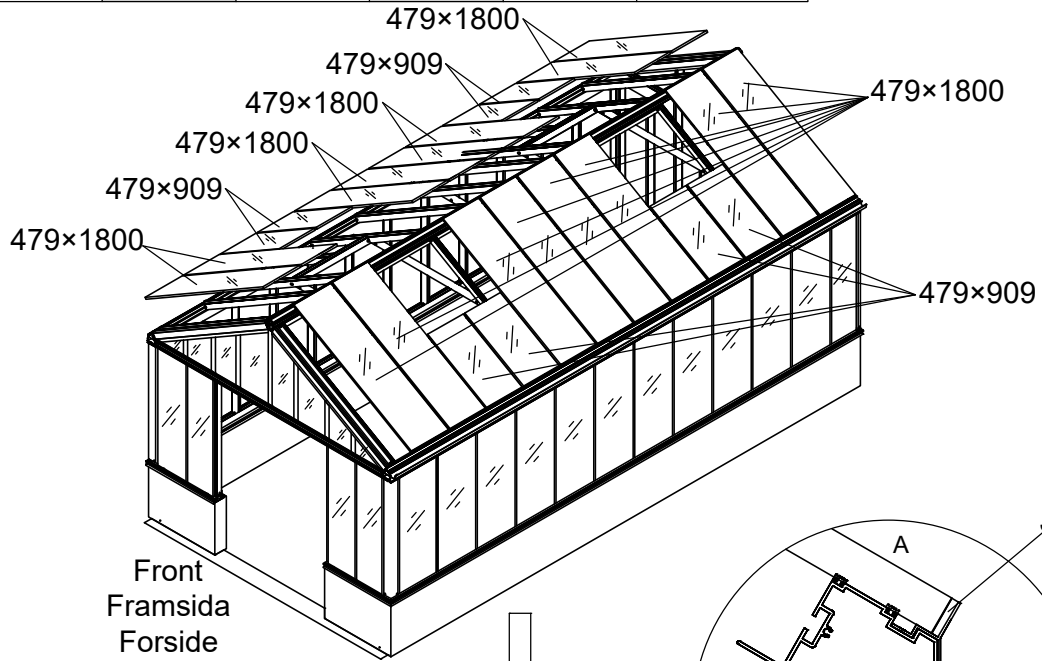

Front
Framsida
Forside
Framsida
Etuipuoli

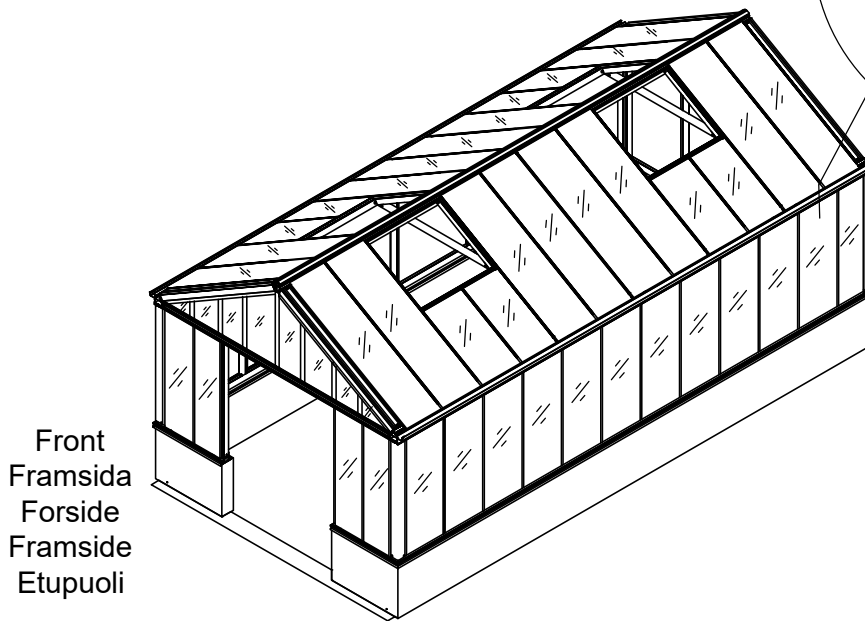
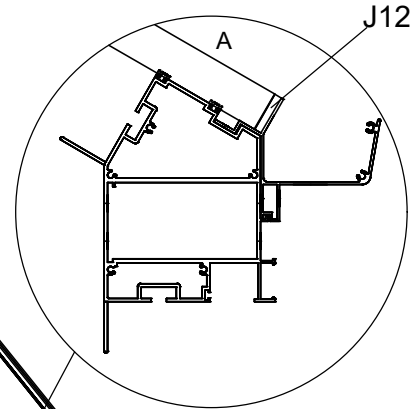

Front
Framsida
Forside
Framsida
Etuipuoli

3721	3722	3723	3724

Part	NO.	QTY.								Length (MM)
		3721		3722		3723		3724		
		SH2GA1-EXTN-2	SH2GA1-EXTW-2	SH2GA1-EXTN-2	SH2GA1-EXTW-2	SH2GA1-EXTN-2	SH2GA1-EXTW-2	SH2GA1-EXTN-2	SH2GA1-EXTW-2	
	41X-Y102	8	4	12	4	12	8	16	8	480

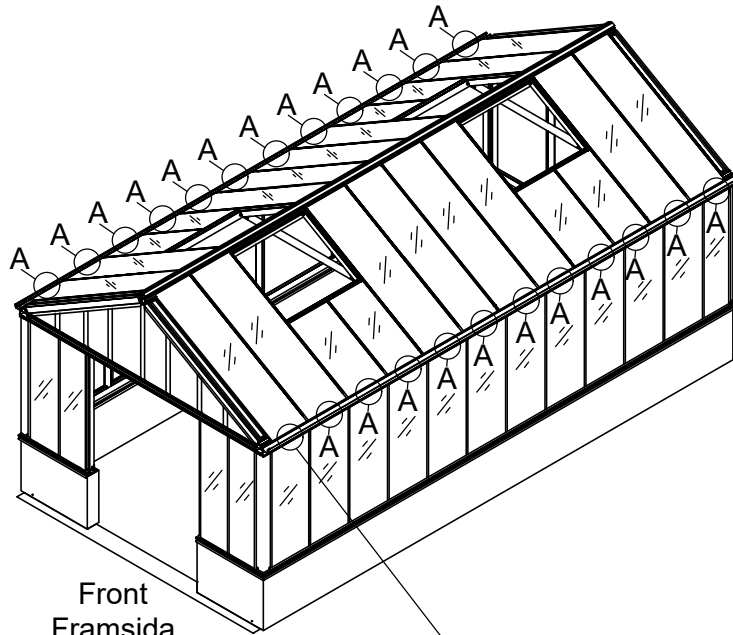

Front
Framsida
Forside
Framsida
Etupuoli

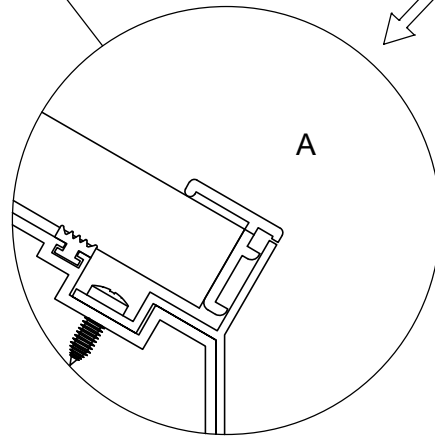
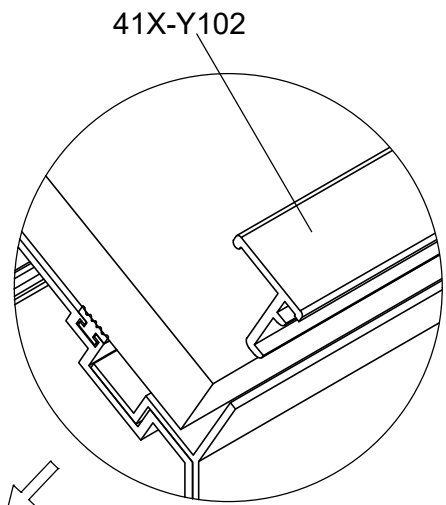

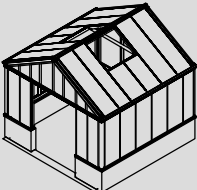
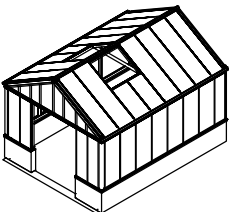
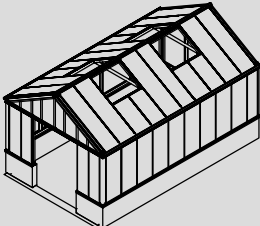
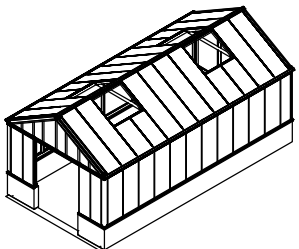



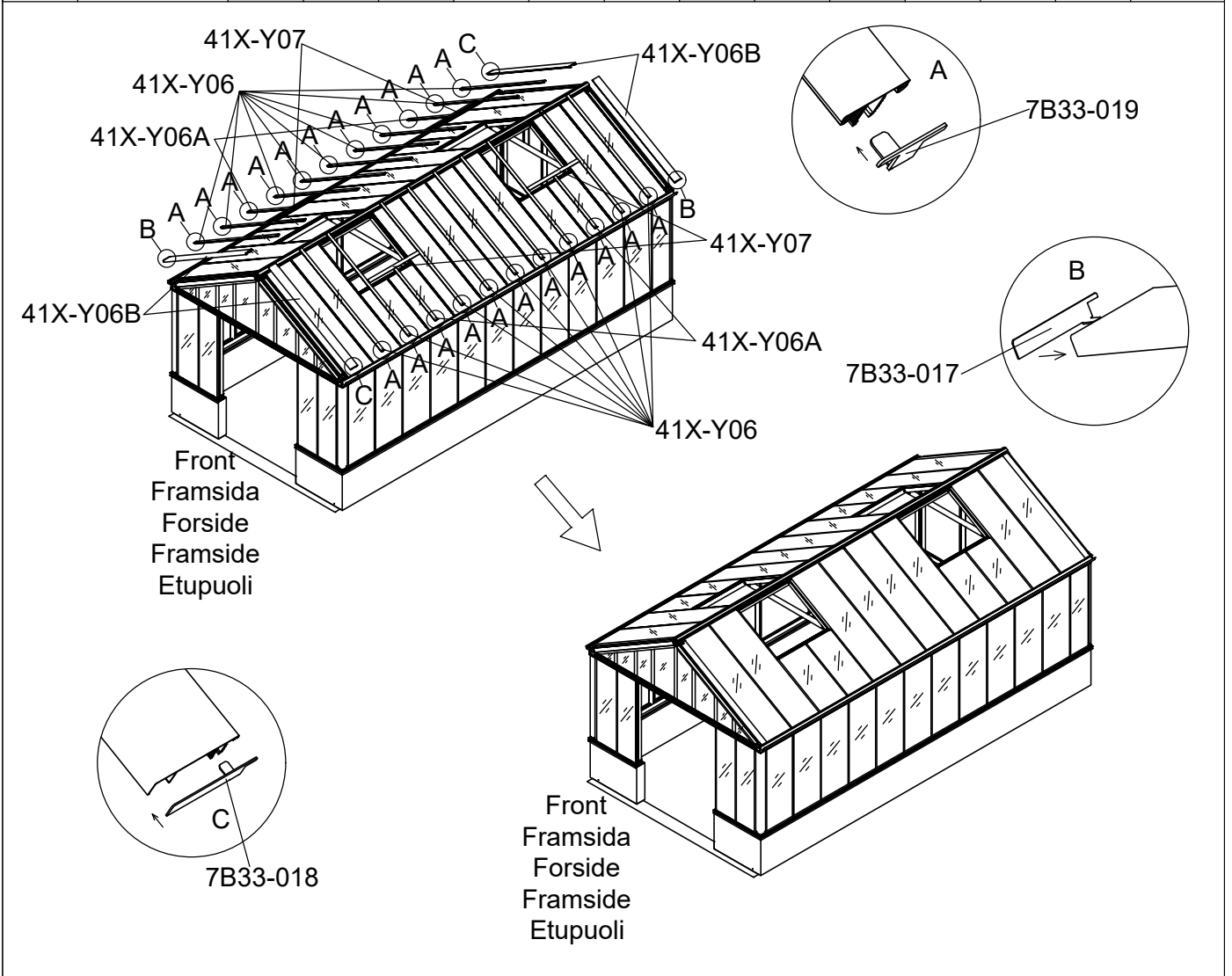



3721	3722	3723	3724
			







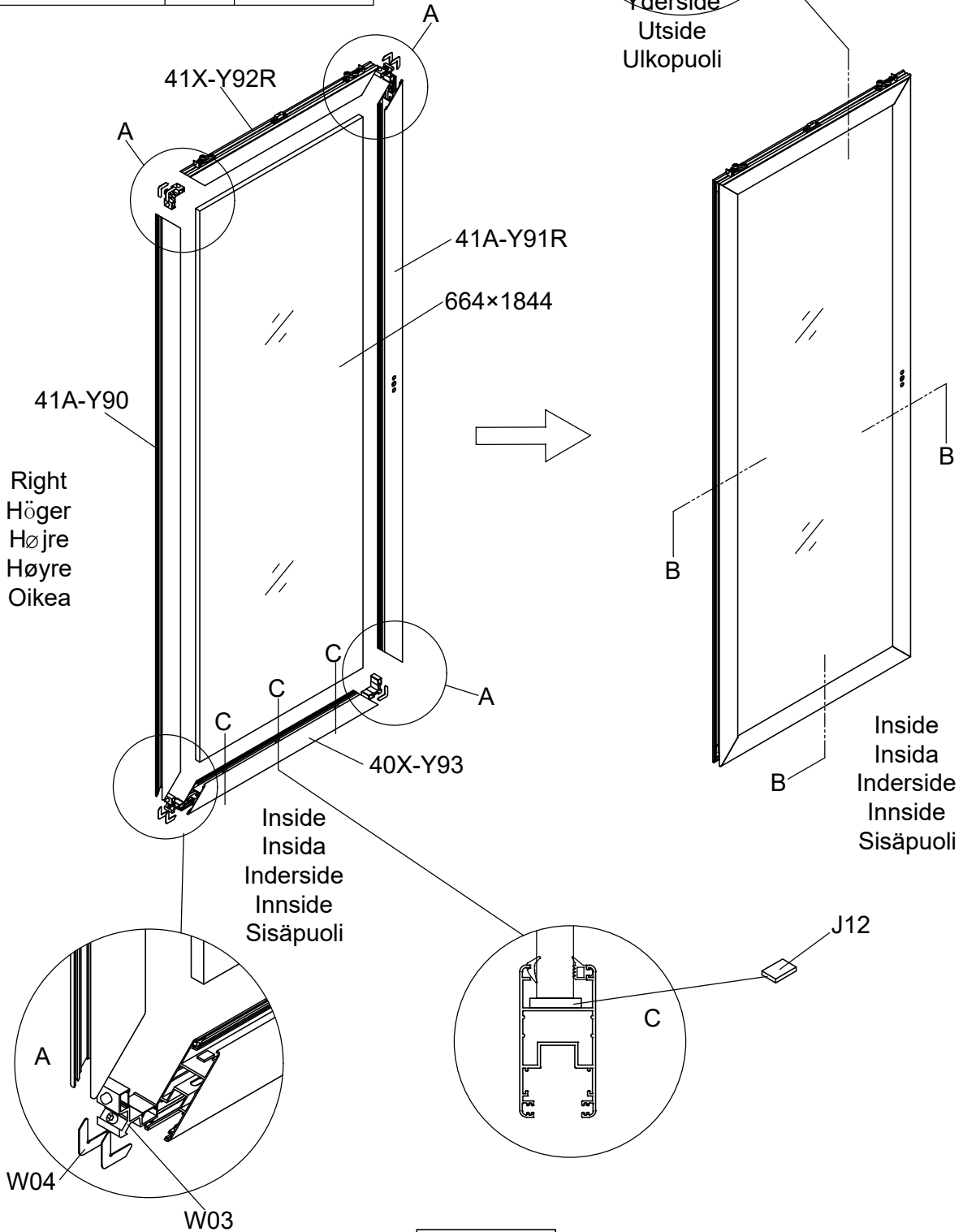
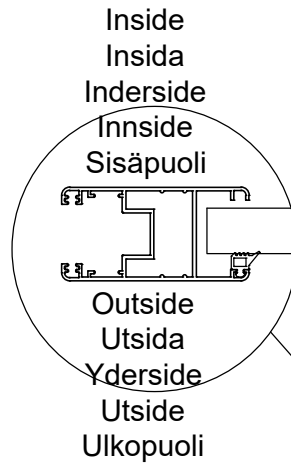

Part	NO.	QTY.											Length (MM)	
		3721			3722			3723			3724			
		3721	SH2GA1-EXTN-2	SH2GA1-EXTW-2	3722	SH2GA1-EXTN-2	SH2GA1-EXTW-2	3723	SH2GA1-EXTN-2	SH2GA1-EXTW-2	3724	SH2GA1-EXTN-2		SH2GA1-EXTW-2
	41X-Y06	4	4	0	6	6	0	8	6	0	10	8	0	1782
	41X-Y06A	0	0	2	0	0	2	0	0	4	0	0	4	890
	41X-Y06B	4	0	0	4	0	0	4	0	0	4	0	0	1782
	41X-Y07	2	0	0	2	0	0	4	0	0	4	0	0	950
	7B33-019	4	4	2	6	6	2	8	6	4	10	8	4	PCS
	7B33-017	2	0	0	2	0	0	2	0	0	2	0	0	PCS
	7B33-018	2	0	0	2	0	0	2	0	0	2	0	0	PCS





3721	3722	3723	3724

Part	NO.	QTY.	Length(MM)
	664×1844	1	1844
	41A-Y90	1	1958
	41A-Y91R	1	1958
	41X-Y92R	1	776
	41X-Y93	1	776
	W03	4	30
	W04	8	PCS
	J12	3	PCS



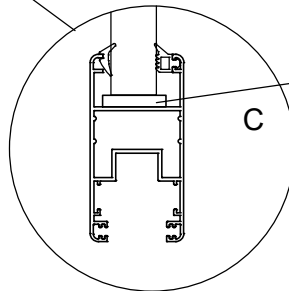
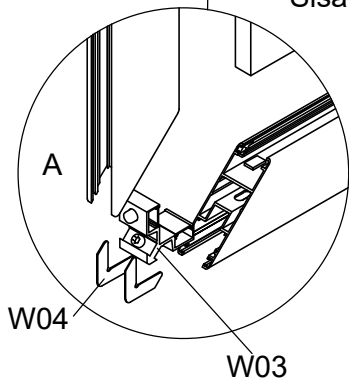
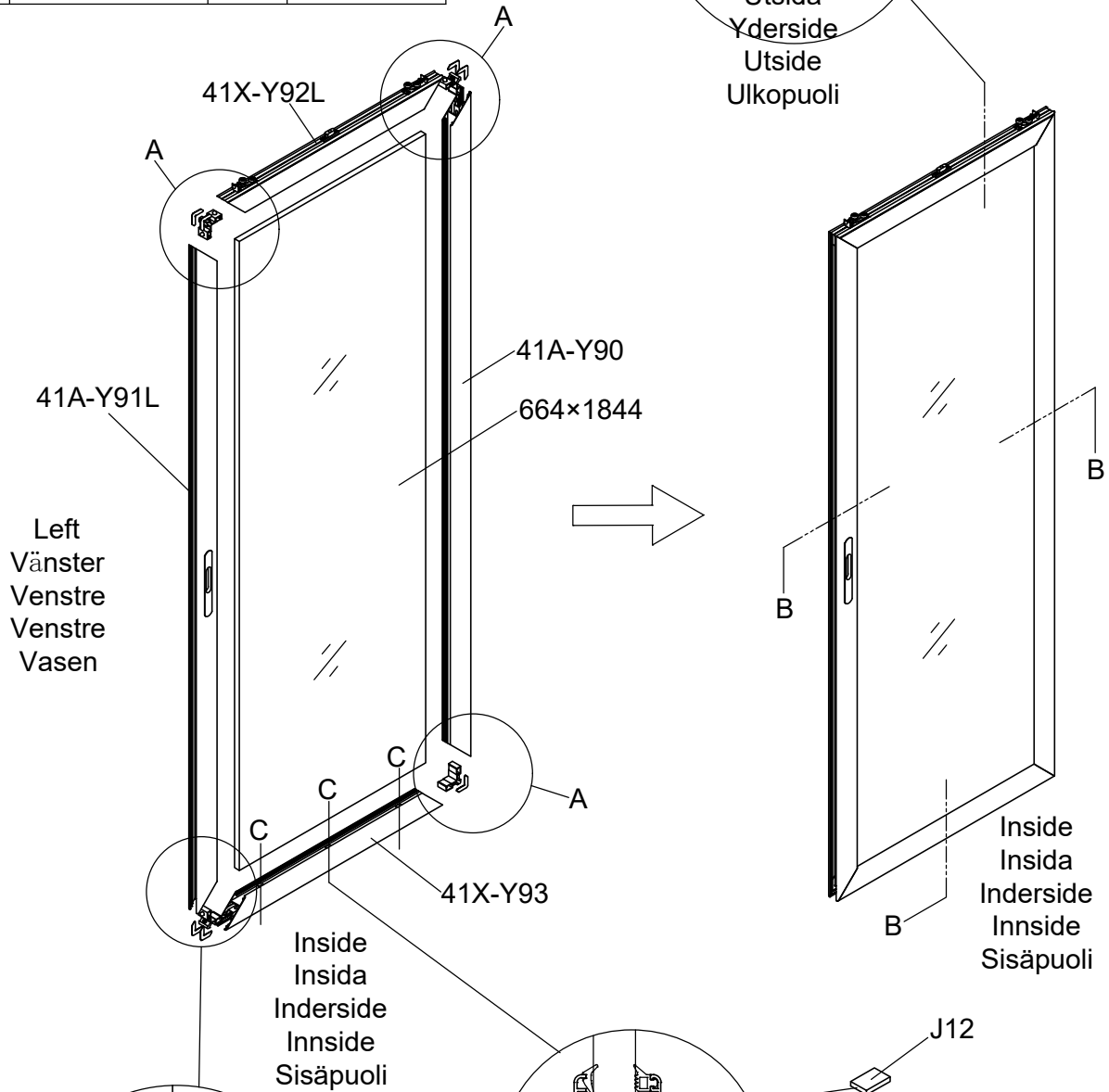
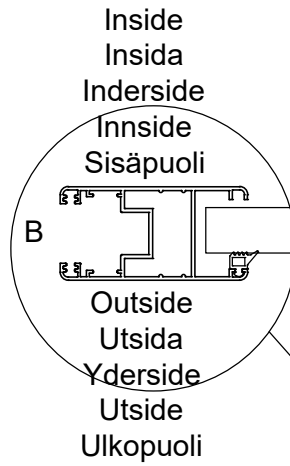



Part	NO.	QTY.	Length(MM)
	664×1844	1	1844
	41A-Y90	1	1958
	41A-Y91L	1	1958
	41X-Y92L	1	776
	41X-Y93	1	776
	W03	4	30
	W04	8	PCS
	J12	3	PCS

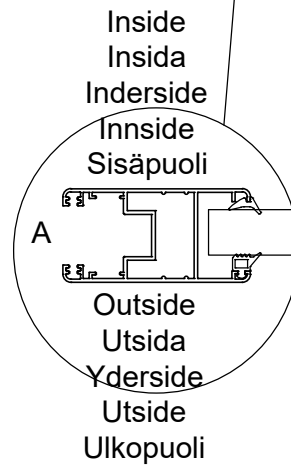
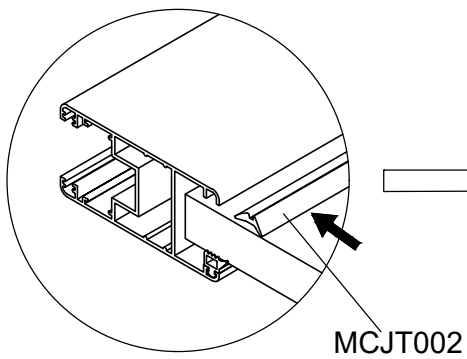
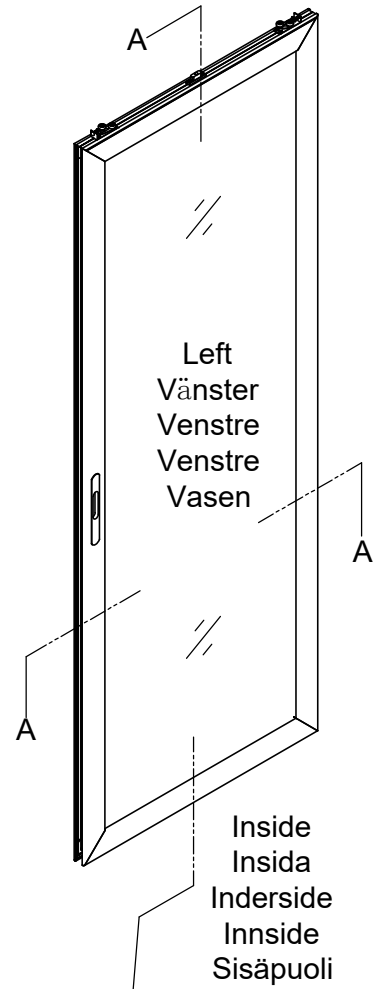
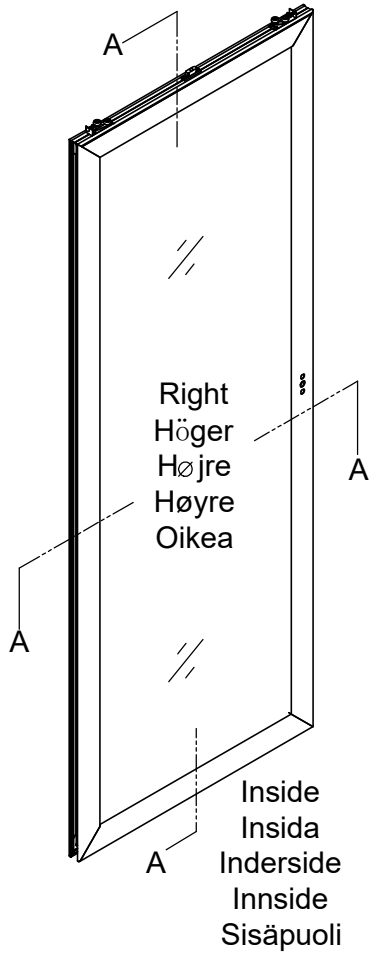





Part	NO.	QTY.	Length(MM)
	MCJT002	12M	

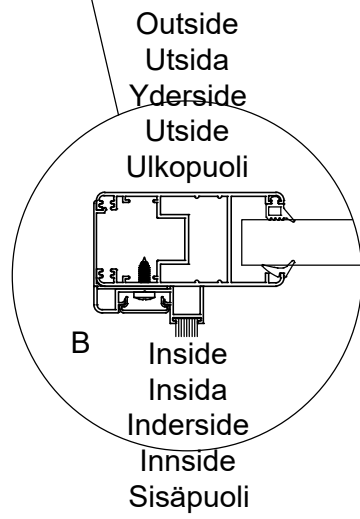
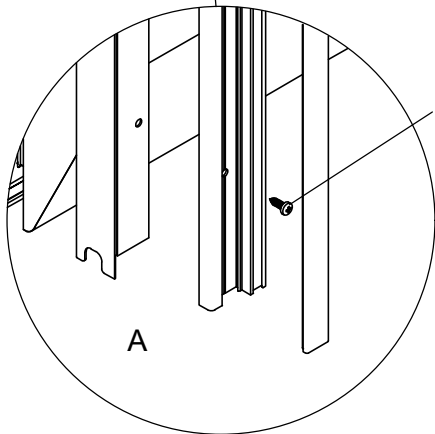
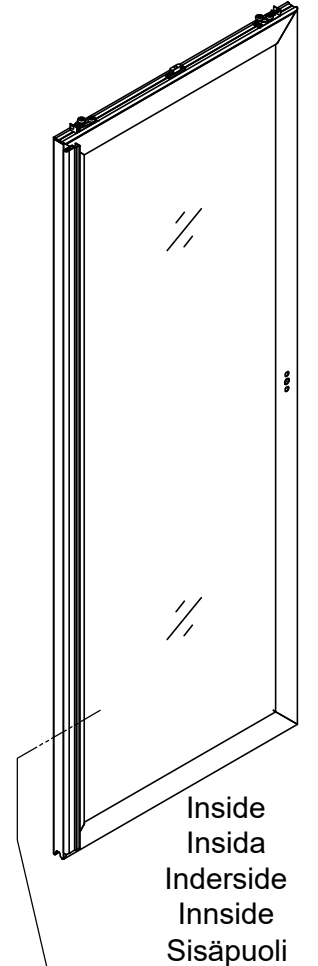
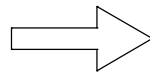
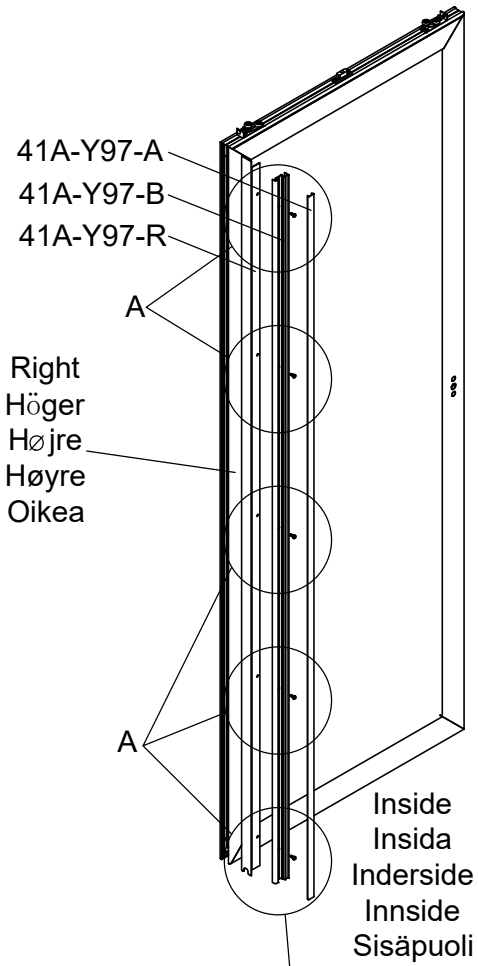





Part	NO.	QTY.	Length(MM)
	41A-Y97-R	1	1951
	41A-Y97-B	1	1918
	41A-Y97-A	1	1918
	Z4.2-13	5	PCS

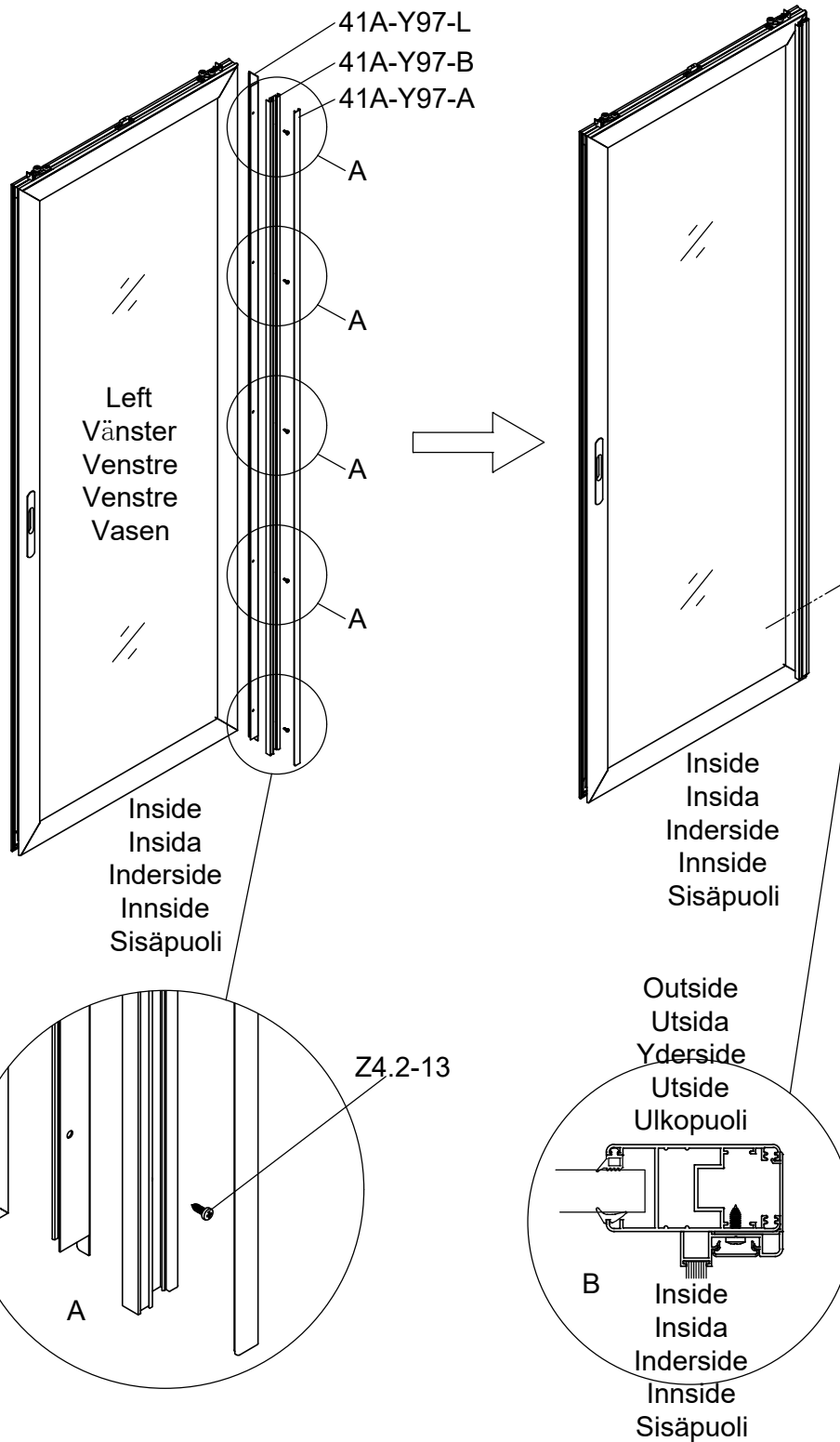





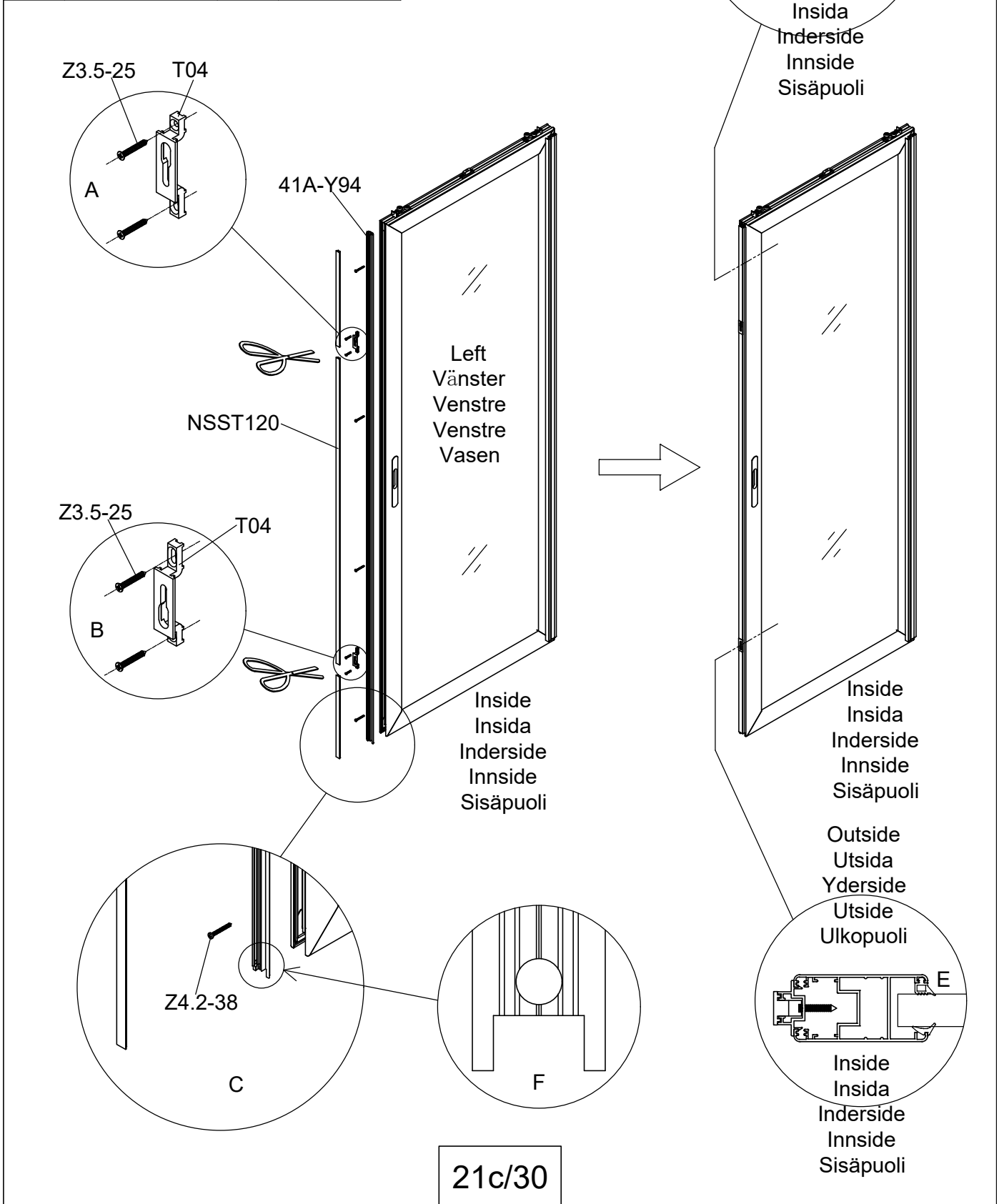

Part	NO.	QTY.	Length(MM)
	41A-Y97-L	1	1951
	41A-Y97-B	1	1918
	41A-Y97-A	1	1918
	Z4.2-13	5	PCS



Part	NO.	QTY.	Length(MM)
	41A-Y94	1	1946
	NSST120	2.0M	
	T04	2	PCS
	Z4.2-38	4	PCS
	Z3.5-25	4	PCS



21c/30

Part	NO.	QTY.	Length(MM)
	41A-Y98-R	1	2000
	41A-Y98-L	1	2000
	M8-35	2	PCS
	Si8-35	2	PCS
	7B33-020	2	PCS
	Si6-35	4	PCS
	J05	4	PCS

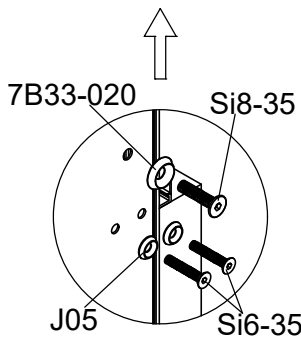
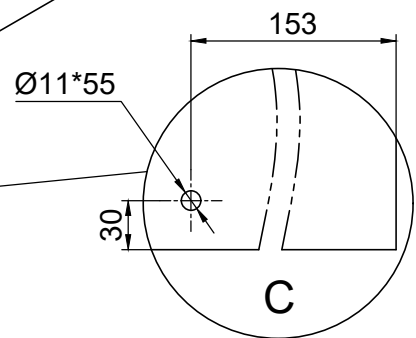
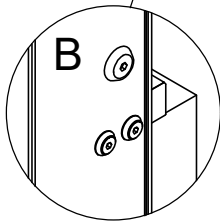
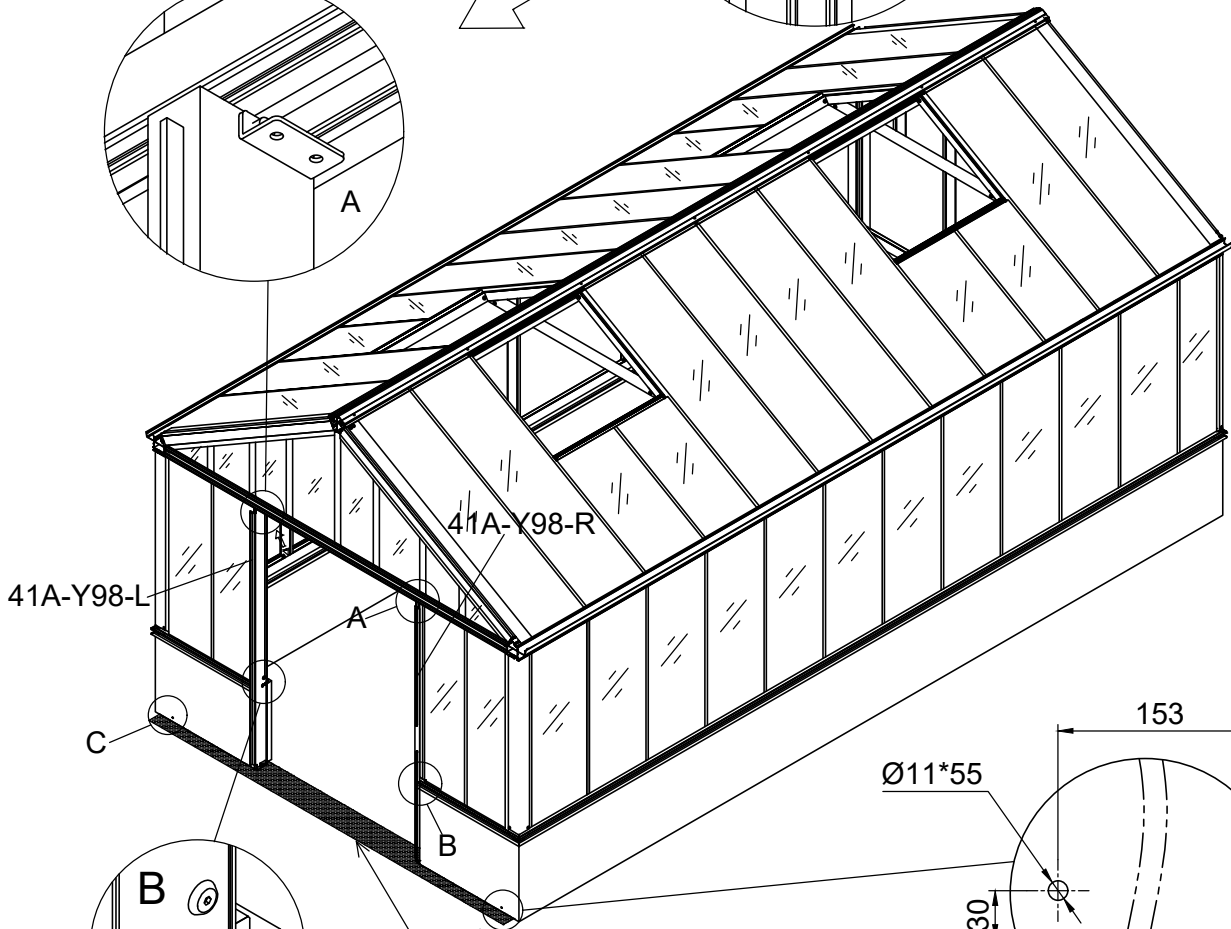
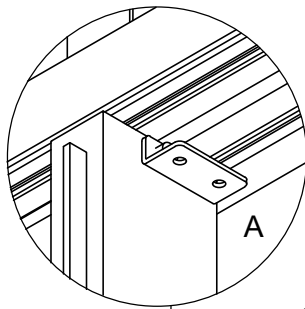
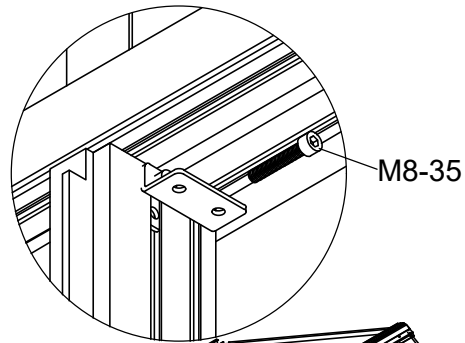

Make sure the floor below the doors frame should be flat and solid.





Se till att underlaget under dörrramen är plan och på solid grund.

Sørg for, at underlaget under dørkarmen er plan og på fast grund.

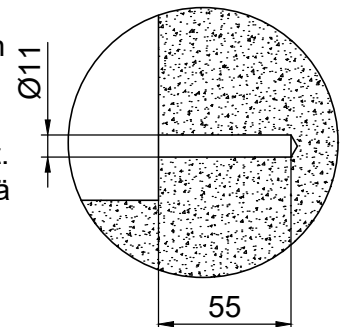



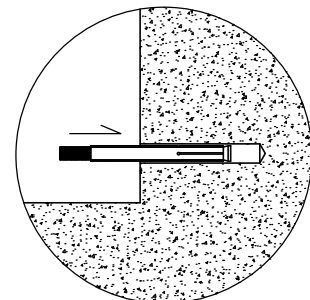
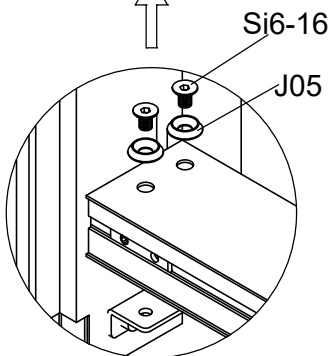
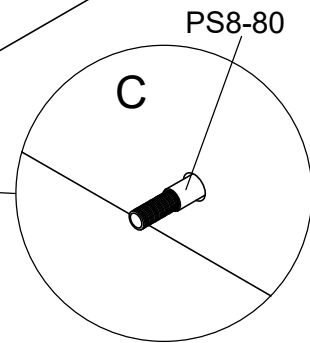
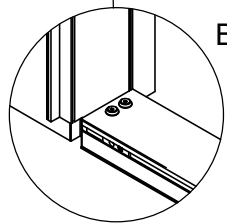
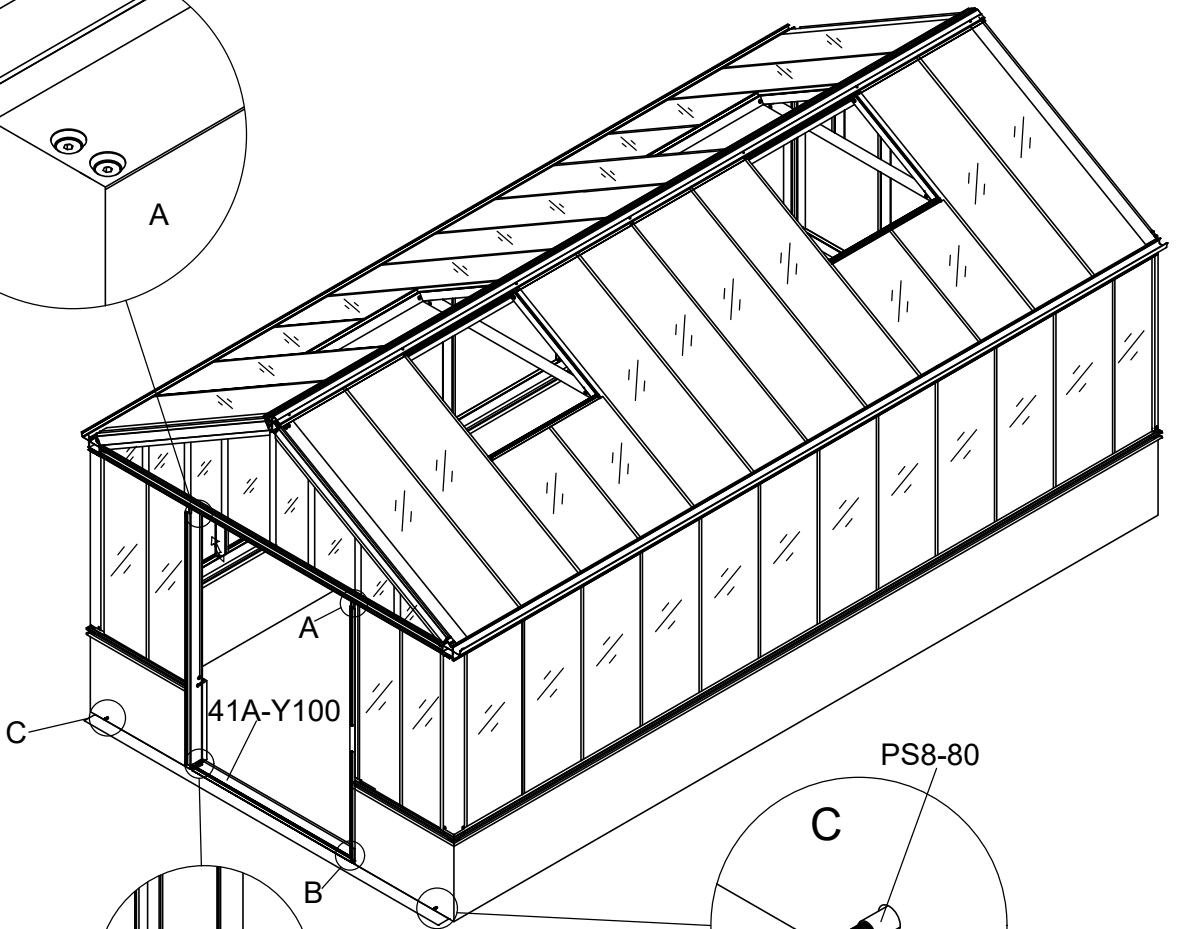
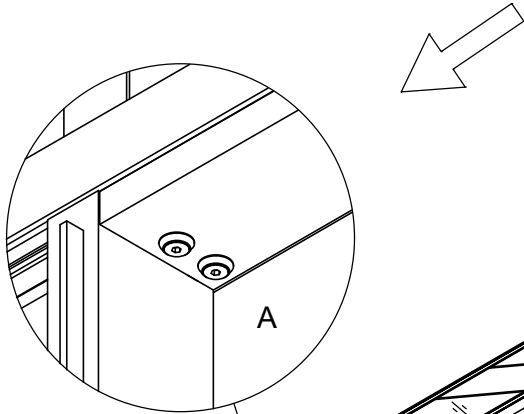
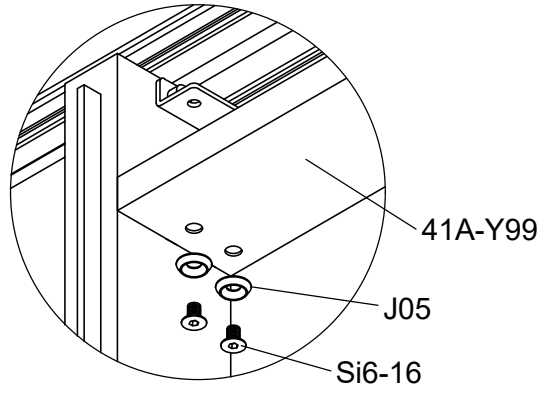

Sørg for at underlaget under dørterskelen er slett og på solid fundament.

Tarkista, että maa ovikarmin alla on sileä ja tasainen.





Part	NO.	QTY.	Length(MM)
	41A-Y99	1	1410
	41A-Y100	1	1410
	Si6-16	8	PCS
	J05	8	PCS
	PS8-80	2	PCS

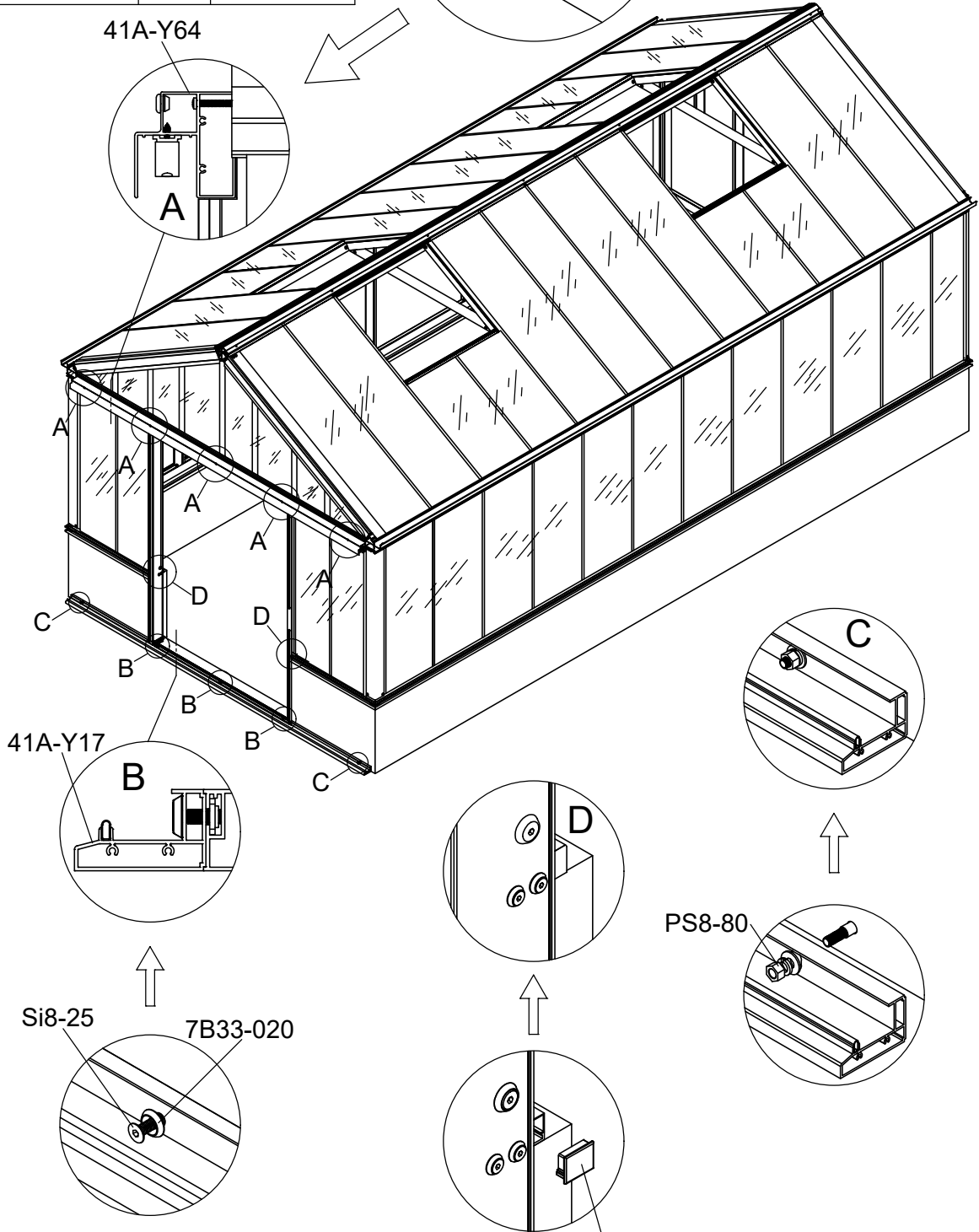
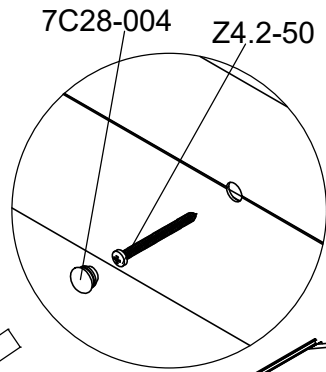

Part	NO.	QTY.	Length(MM)
	41A-Y64	1	3016
	41A-Y17	1	3120
	7C28-004	5	PCS
	Z4.2-50	5	PCS
	Si8-25	3	PCS
	7B33-020	3	PCS
	7C26-031	2	PCS



Part	NO.	QTY.	Length(MM)
 41A-Y98A-R	1	1	1923
 41A-Y98A-L	1	1	1923

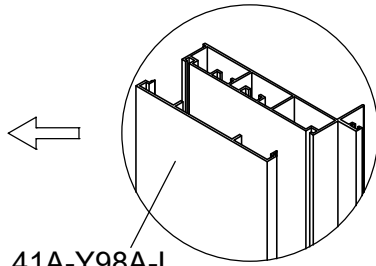
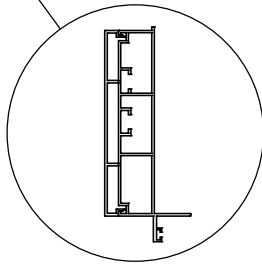
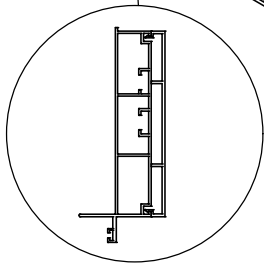
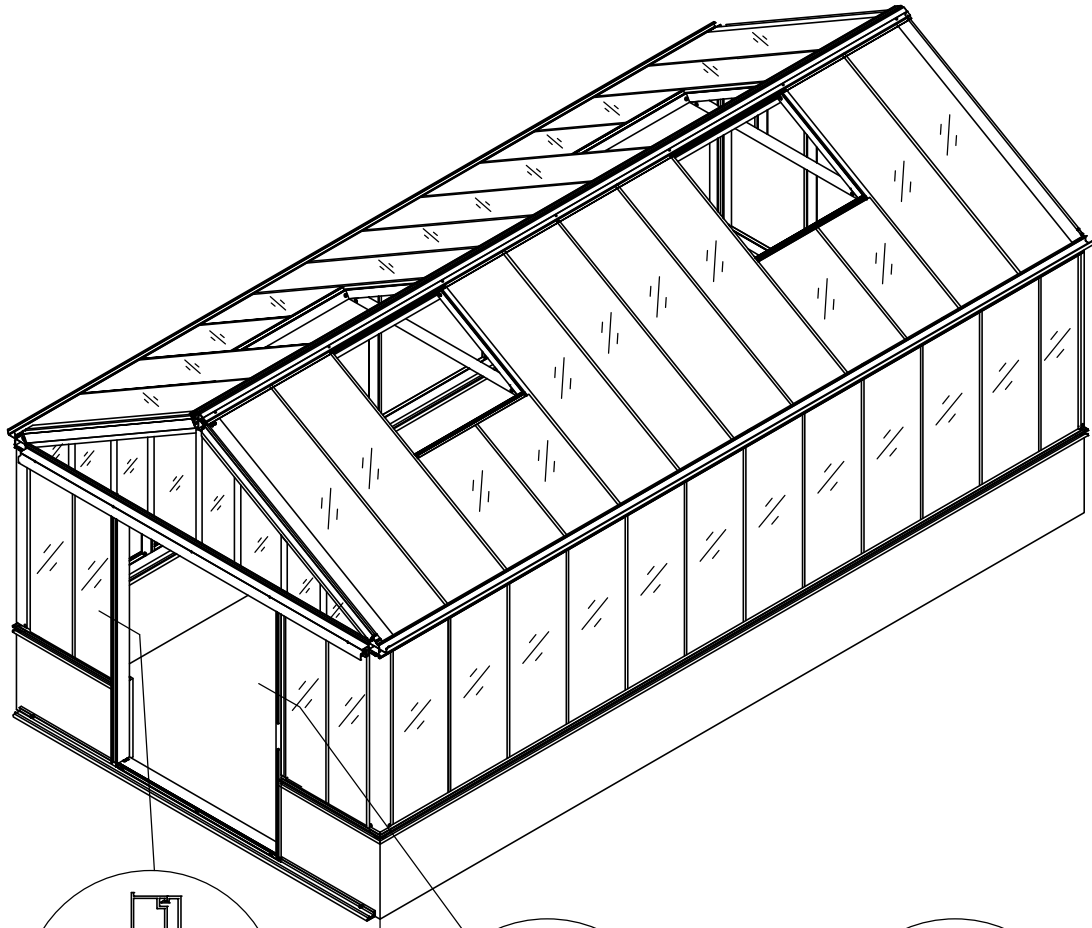

41A-Y98A-L

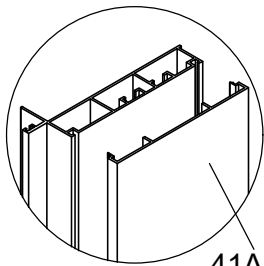



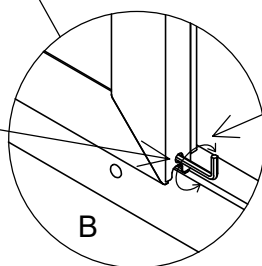
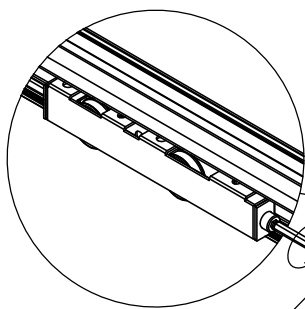
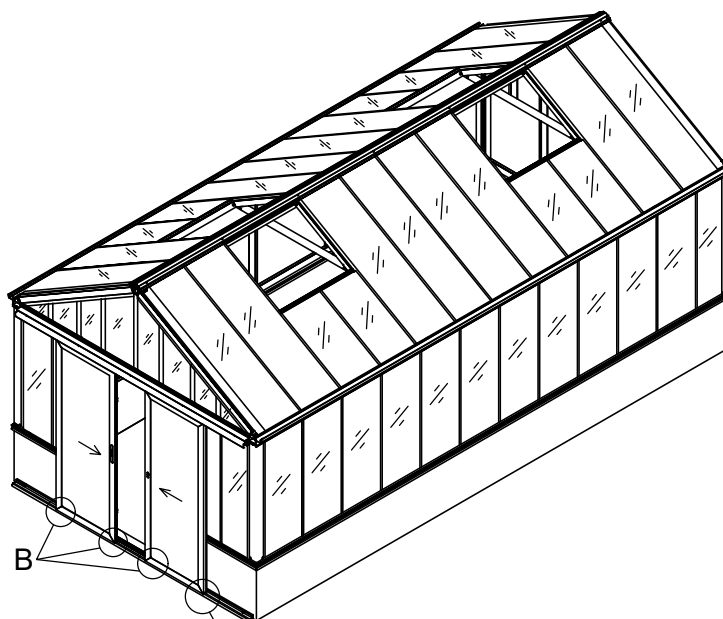
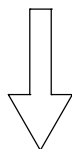
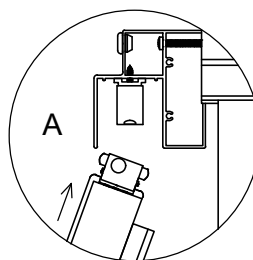
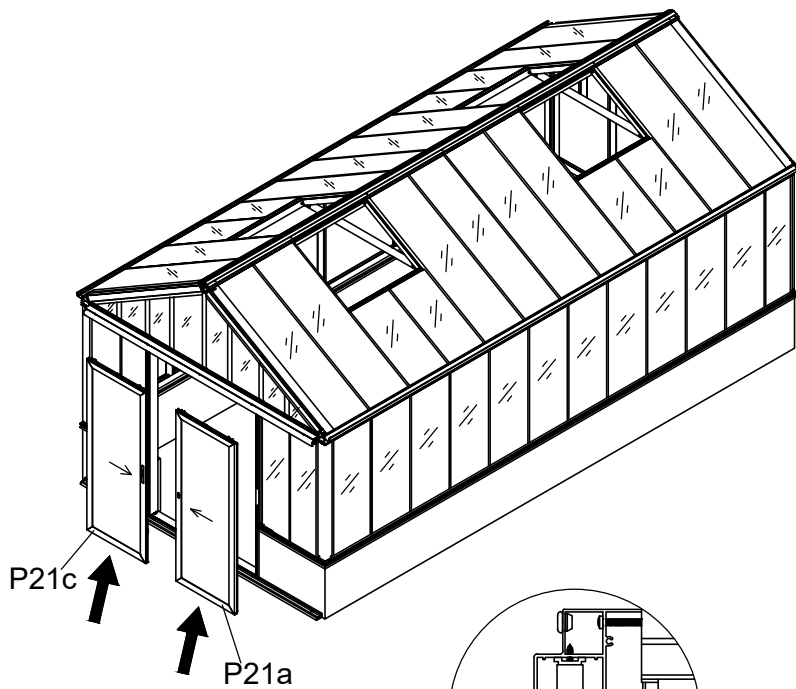







41A-Y98A-L







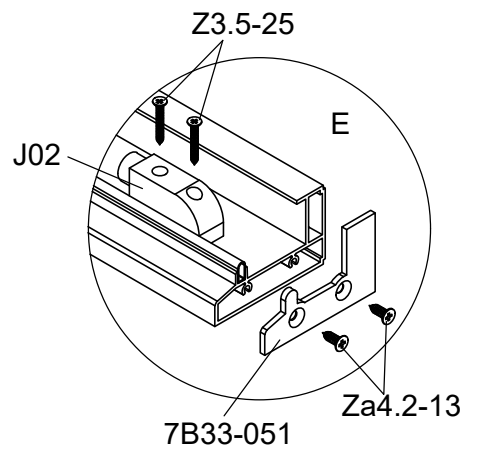
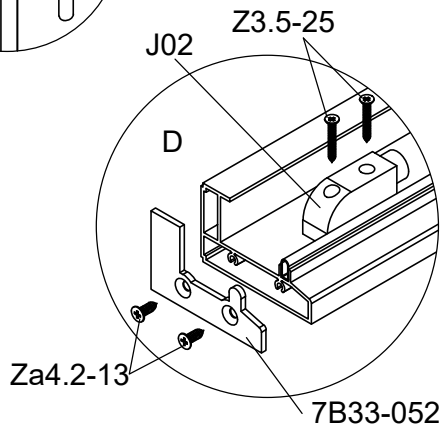
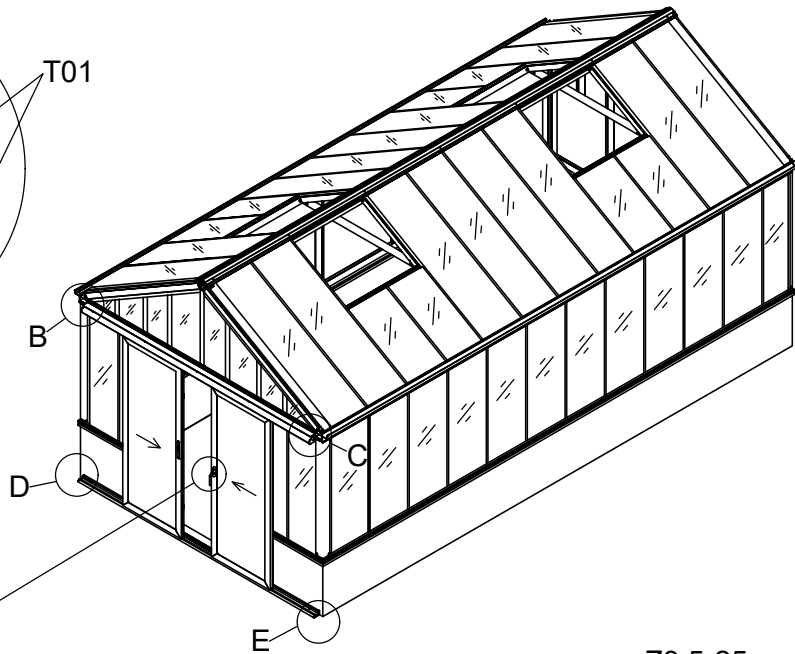
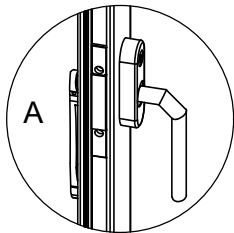
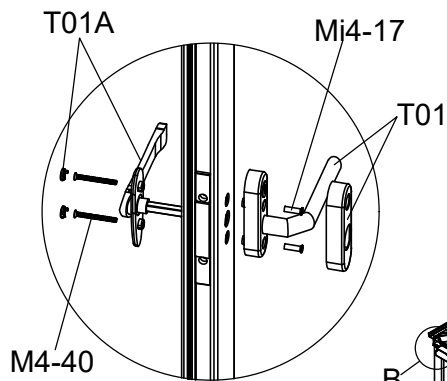
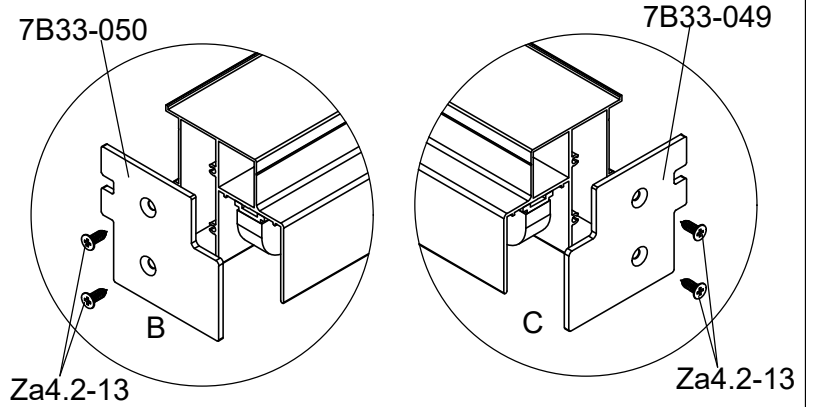

Adjust the height of the wheels
 Justera höjden för hjulen
 Juster højden af hjulene
 Justere høyden for hjulene
 Säädä alapyörien korkeus

Tool
 Verktøj
 Værktøj
 Verktøy
 Työkalu



23c/30

Part	NO.	QTY.	Length(MM)
	T01	1	PCS
	T01A	1	PCS
	J02	2	PCS
	7B33-049	1	PCS
	7B33-050	1	PCS
	7B33-051	1	PCS
	7B33-052	1	PCS
	M4-40	2	PCS
	Mi4-17	2	PCS
	Z3.5-25	4	PCS
	Za4.2-13	8	PCS

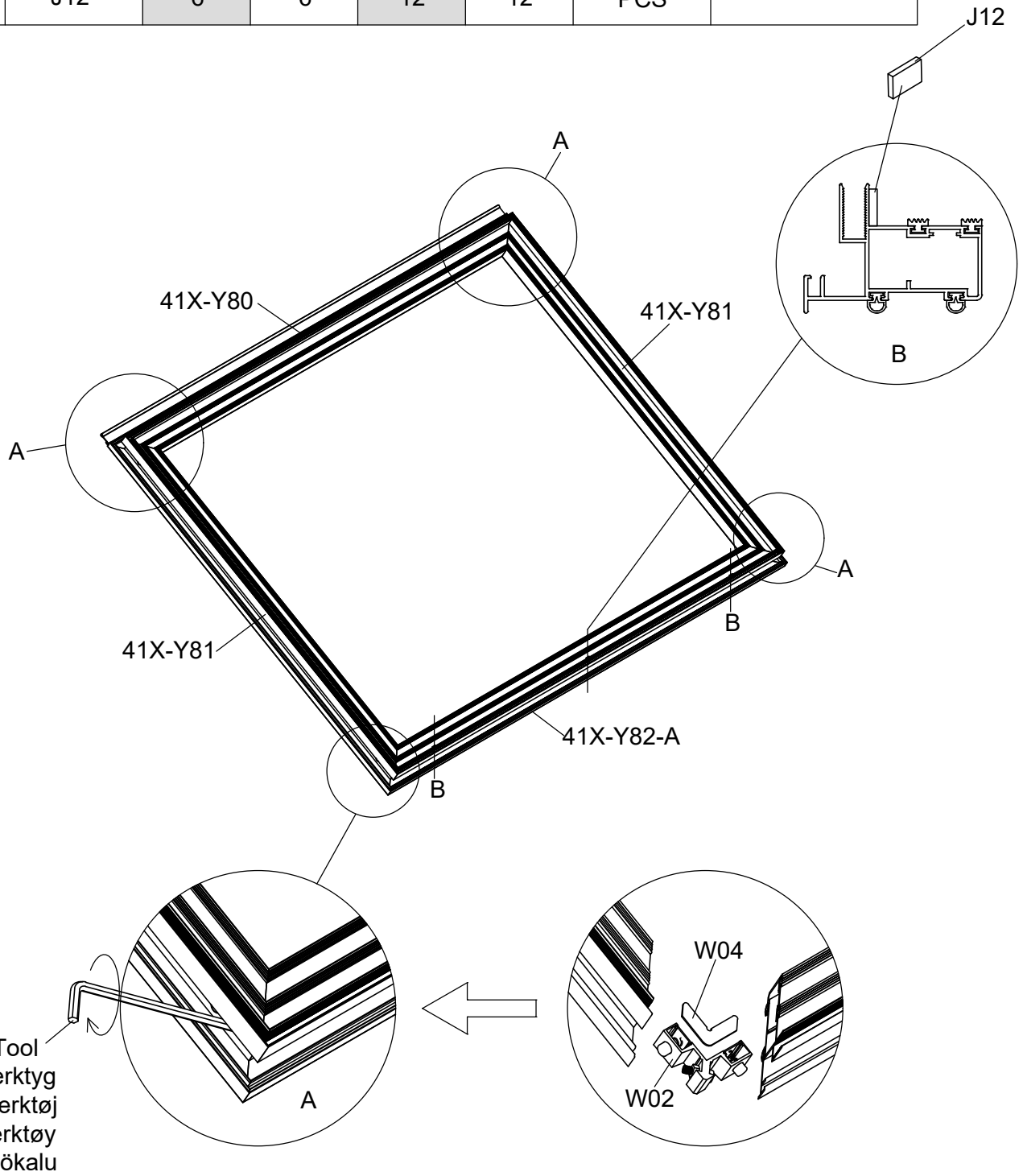

Part	NO.	QTY.				Length(MM)	CTN NO.
		3721	3722	3723	3724		
	41X-Y80	2	2	4	4	1087	
	41X-Y81	4	4	8	8	887	
	41X-Y82-A	2	2	4	4	1087	SH2GA1-EXTW-2
	W02	8	8	16	16	PCS	
	W04	8	8	16	16	PCS	
	J12	6	6	12	12	PCS	



Part	NO.	QTY.				Length(MM)
		3721	3722	3723	3724	
	41X-Y83	4	4	8	8	887
	41X-Y84	4	4	8	8	1076
	1032x831	2	2	4	4	950

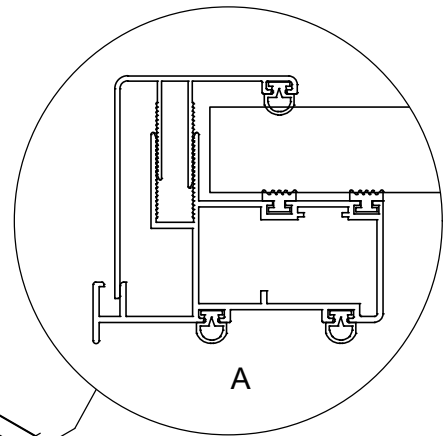
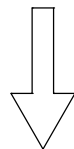
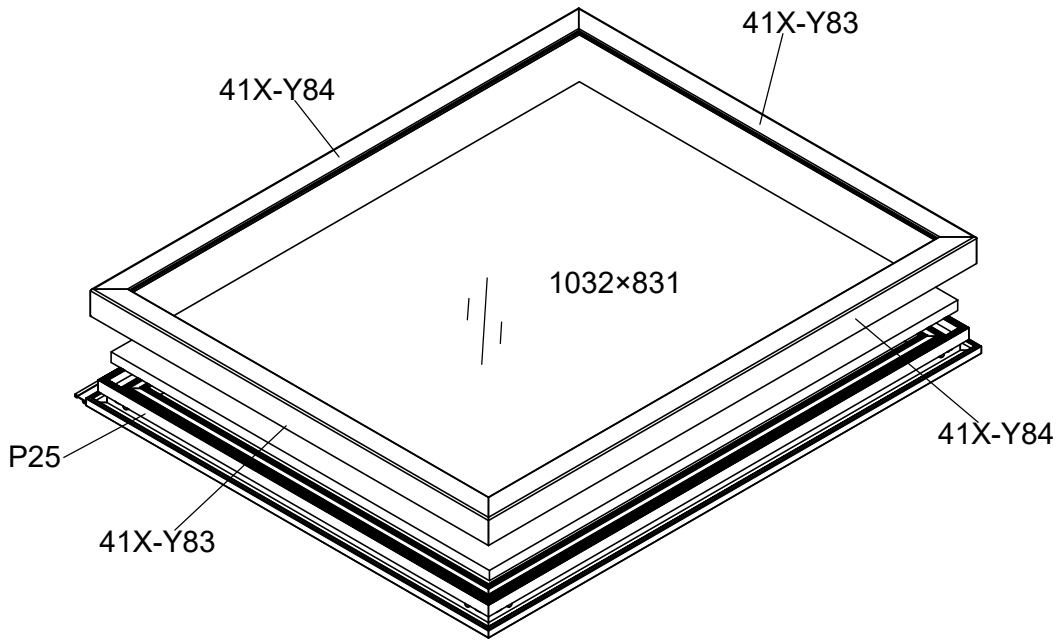

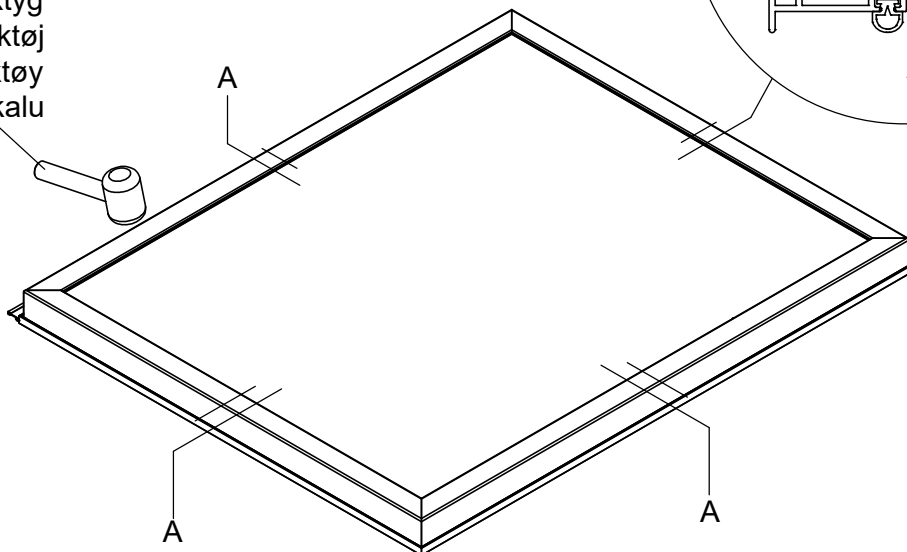

Tool
 Verktug
 Værktøj
 Verktøy
 Työkalu

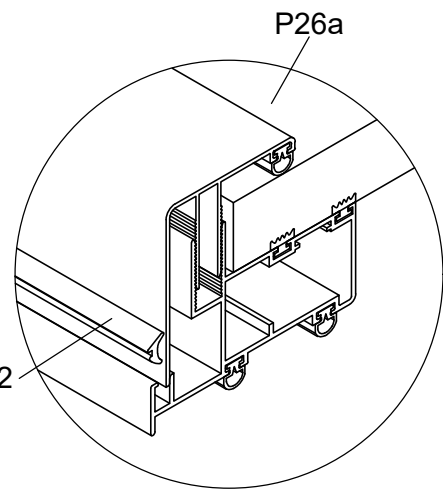
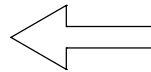
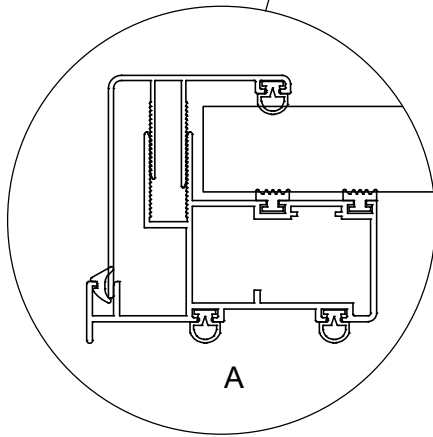
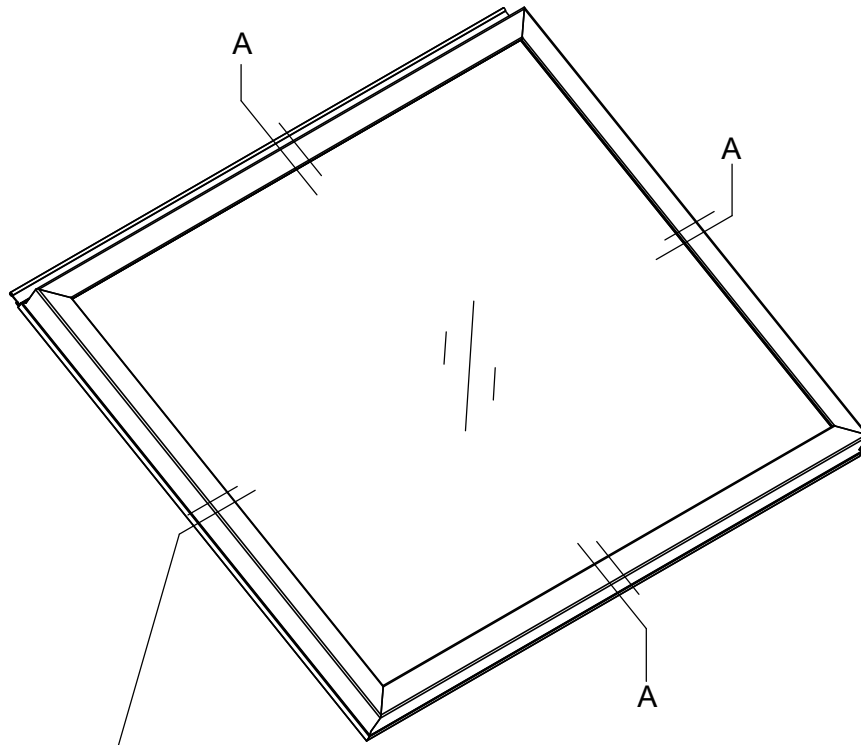

25b/30

Part	NO.	QTY.				Length(MM)
		3721	3722	3723	3724	
	7C26-022	8.5M	8.5M	17M	17M	



Part	NO.	QTY.	Length(MM)
	T07	4	PCS

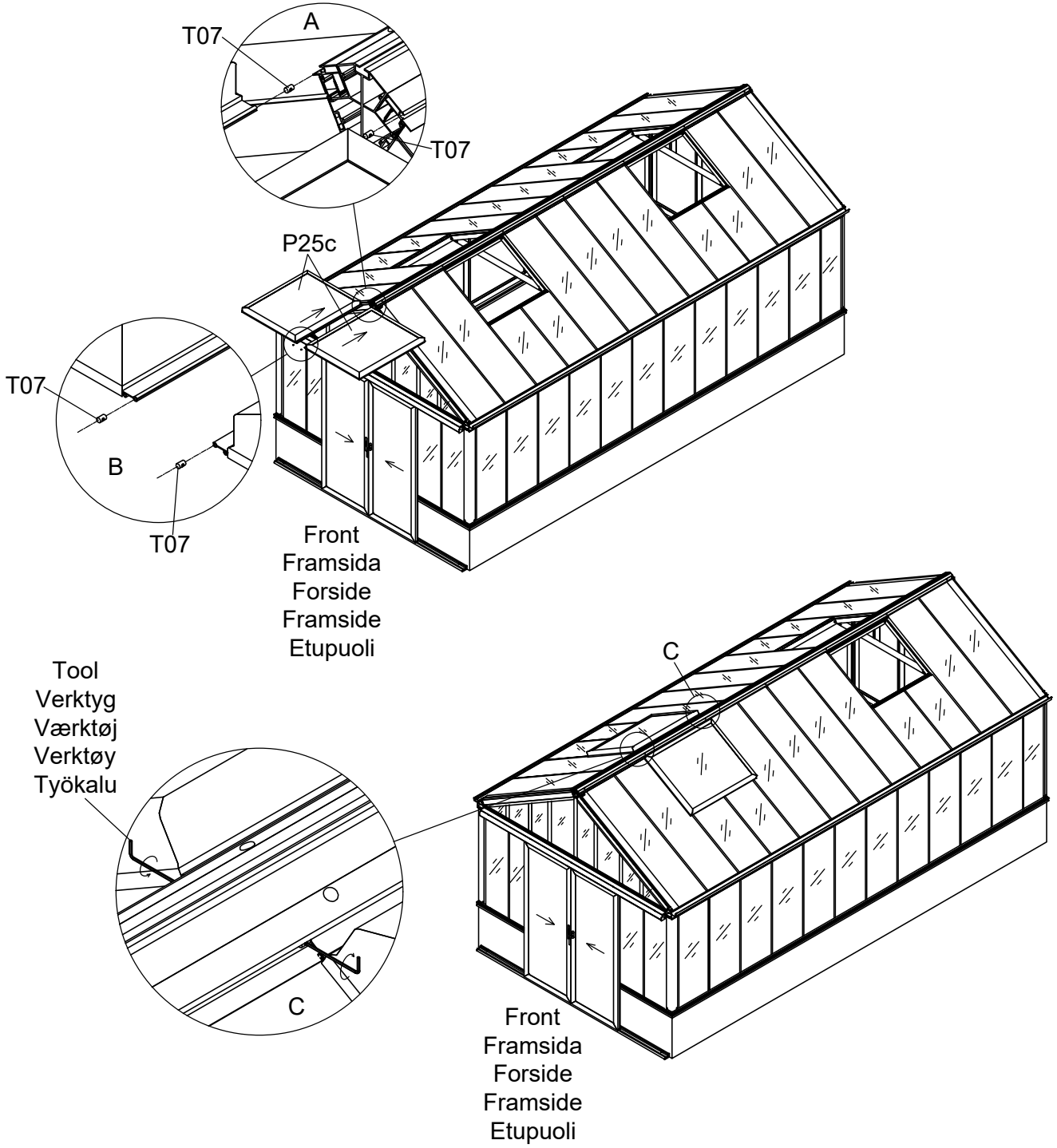

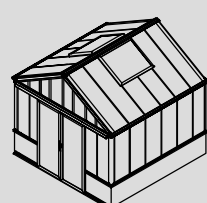
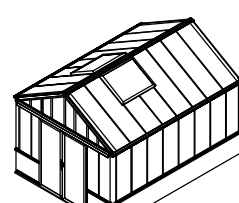
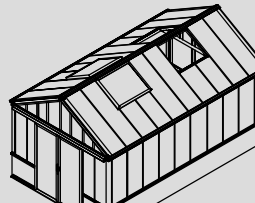
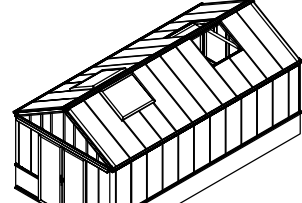
3721	3722	3723	3724
			

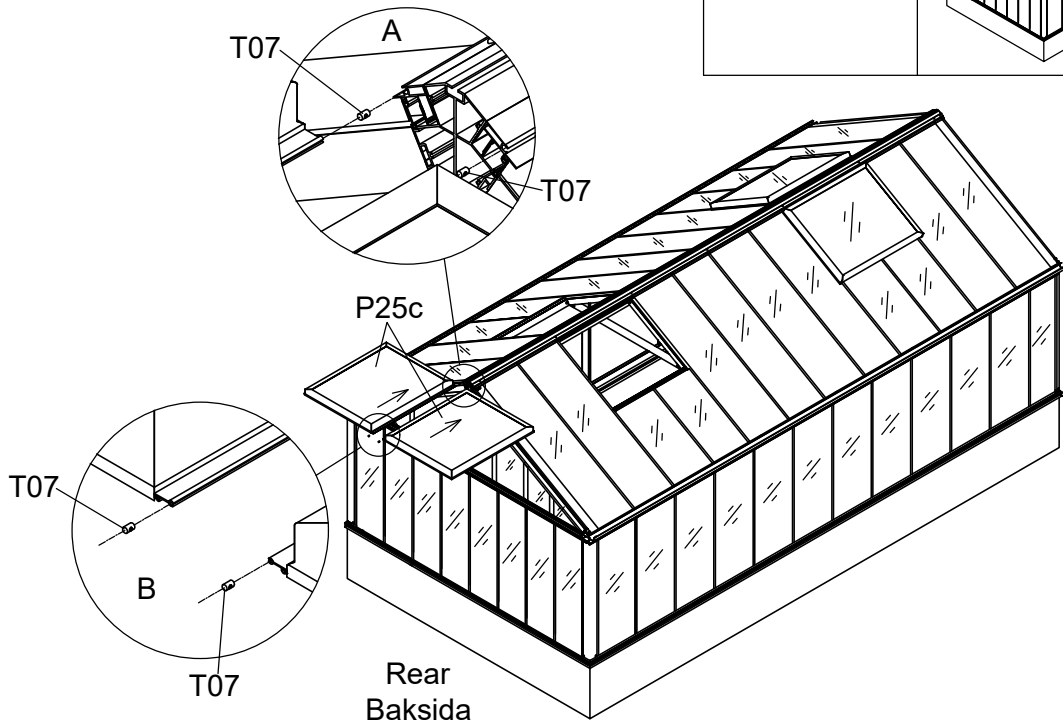
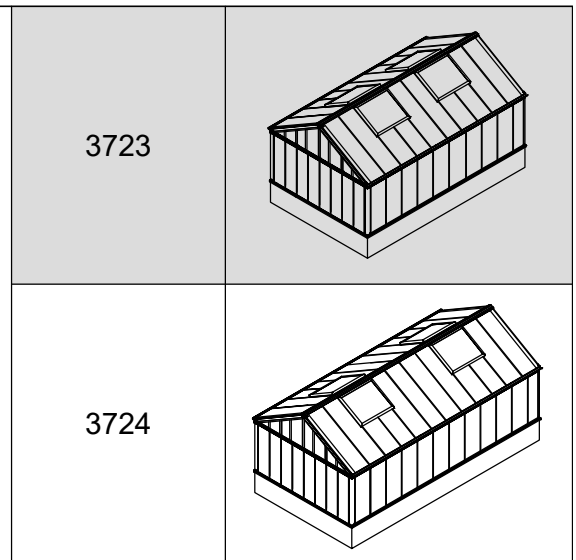

Part	NO.	QTY.		Length(MM)
		3723	3724	
	T07	4	4	PCS

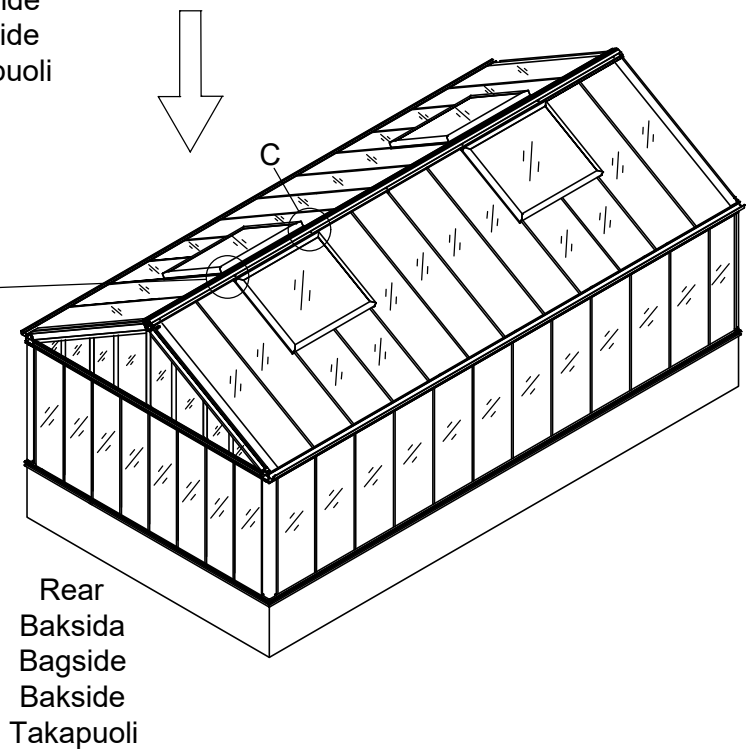
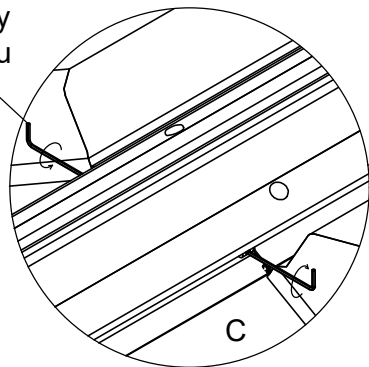

Tool
Verktøj
Værktøj
Verktøy
Työkalu



26b/30

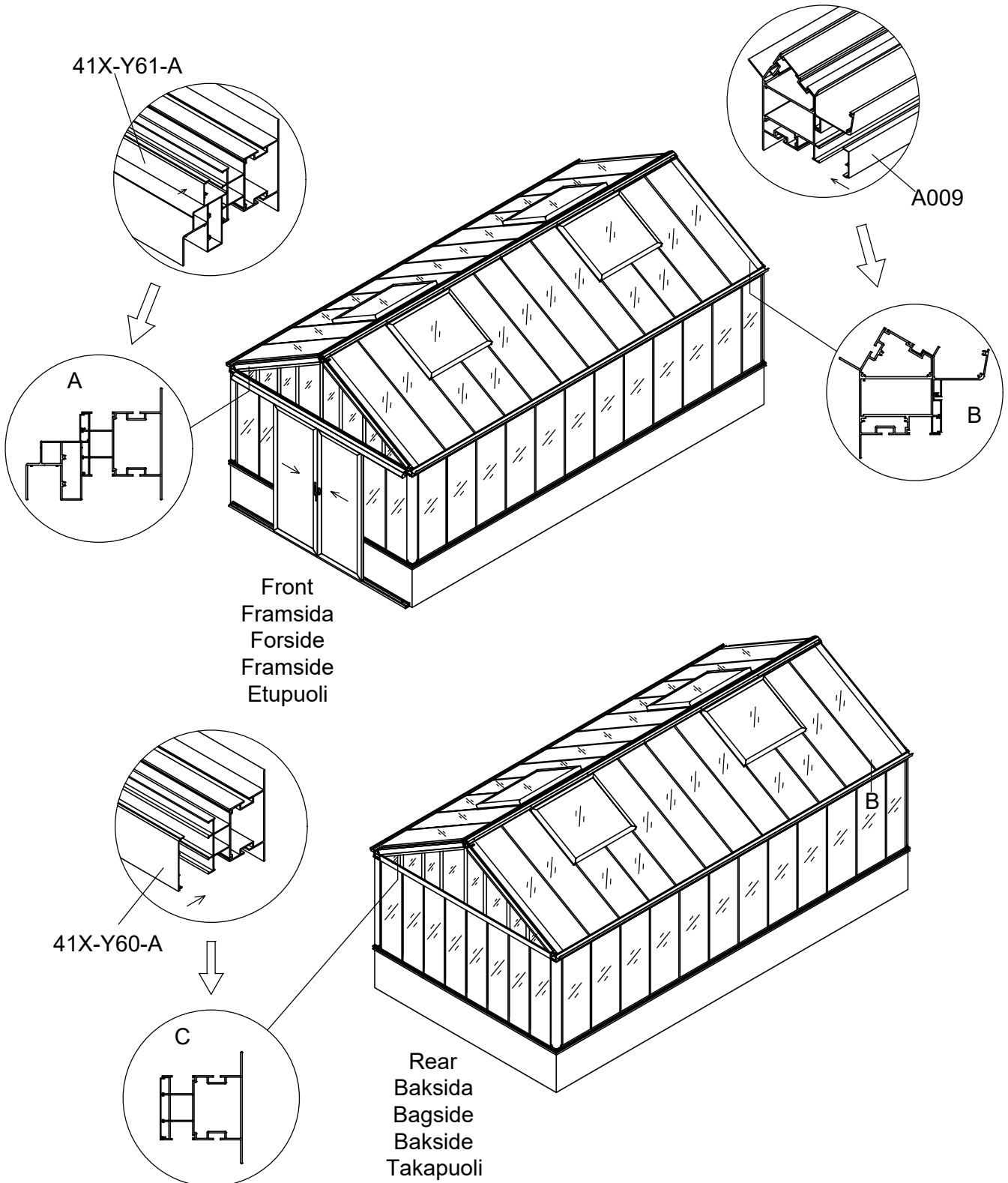

Part	NO.	QTY.	Length(MM)
	41X-Y61-A	1	3023
	41X-Y60-A	1	3023

Part	Product	NO.	Length(MM)	QTY.	Code
	3721	41X-Y62-3A	3227	2	A009
	3722	41X-Y62-4A	4228		
	3723	41X-Y62-5A	5229		
	3724	41X-Y62-6A	6230		



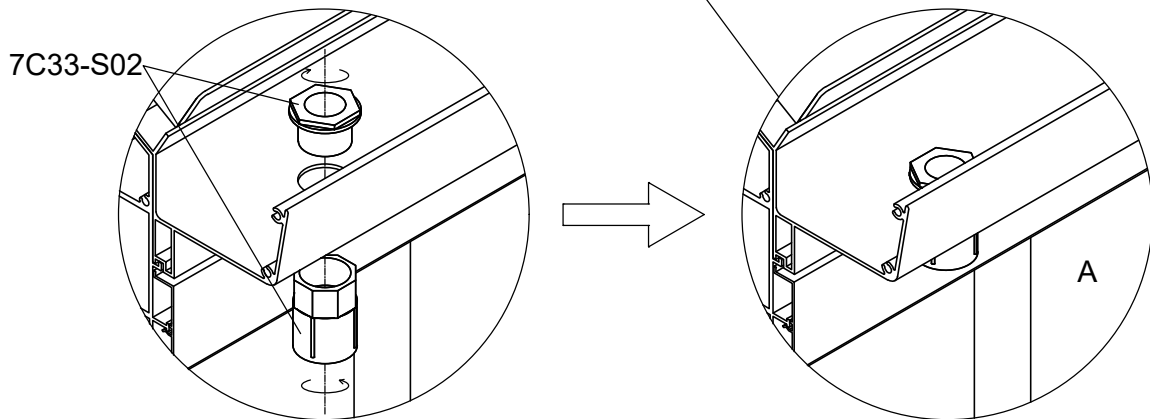
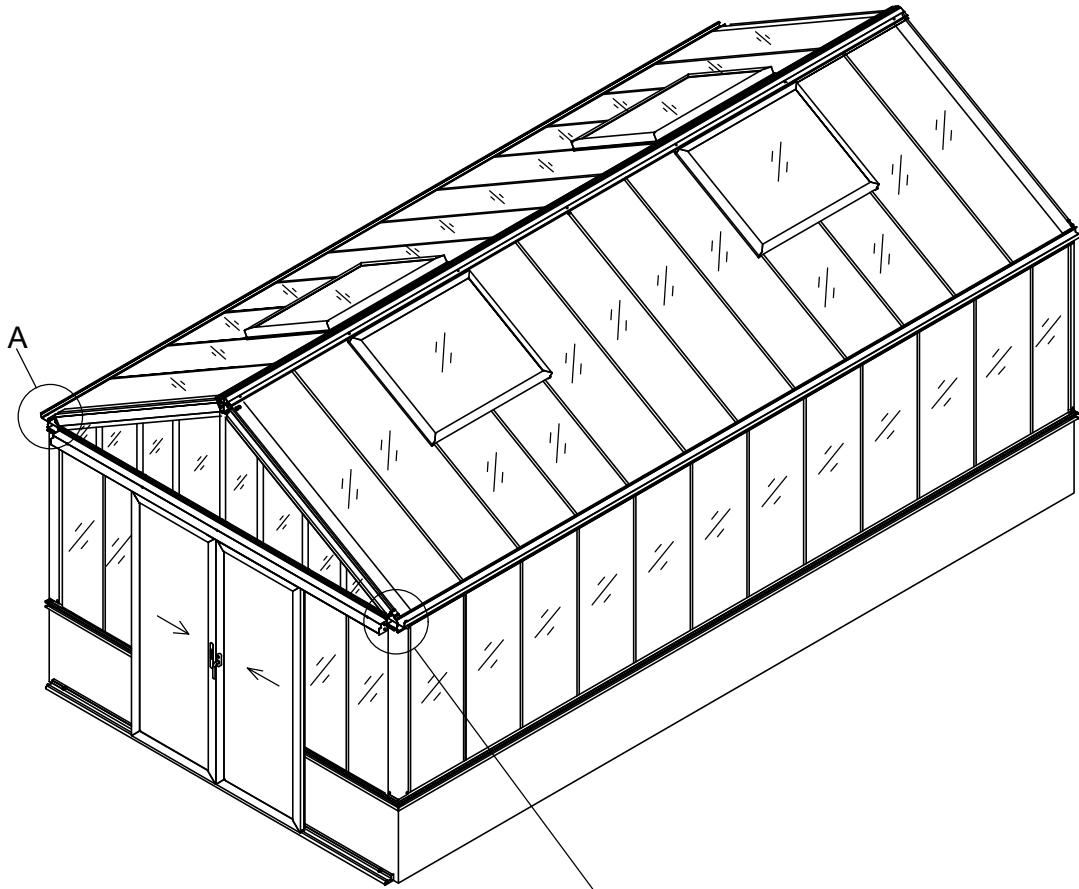



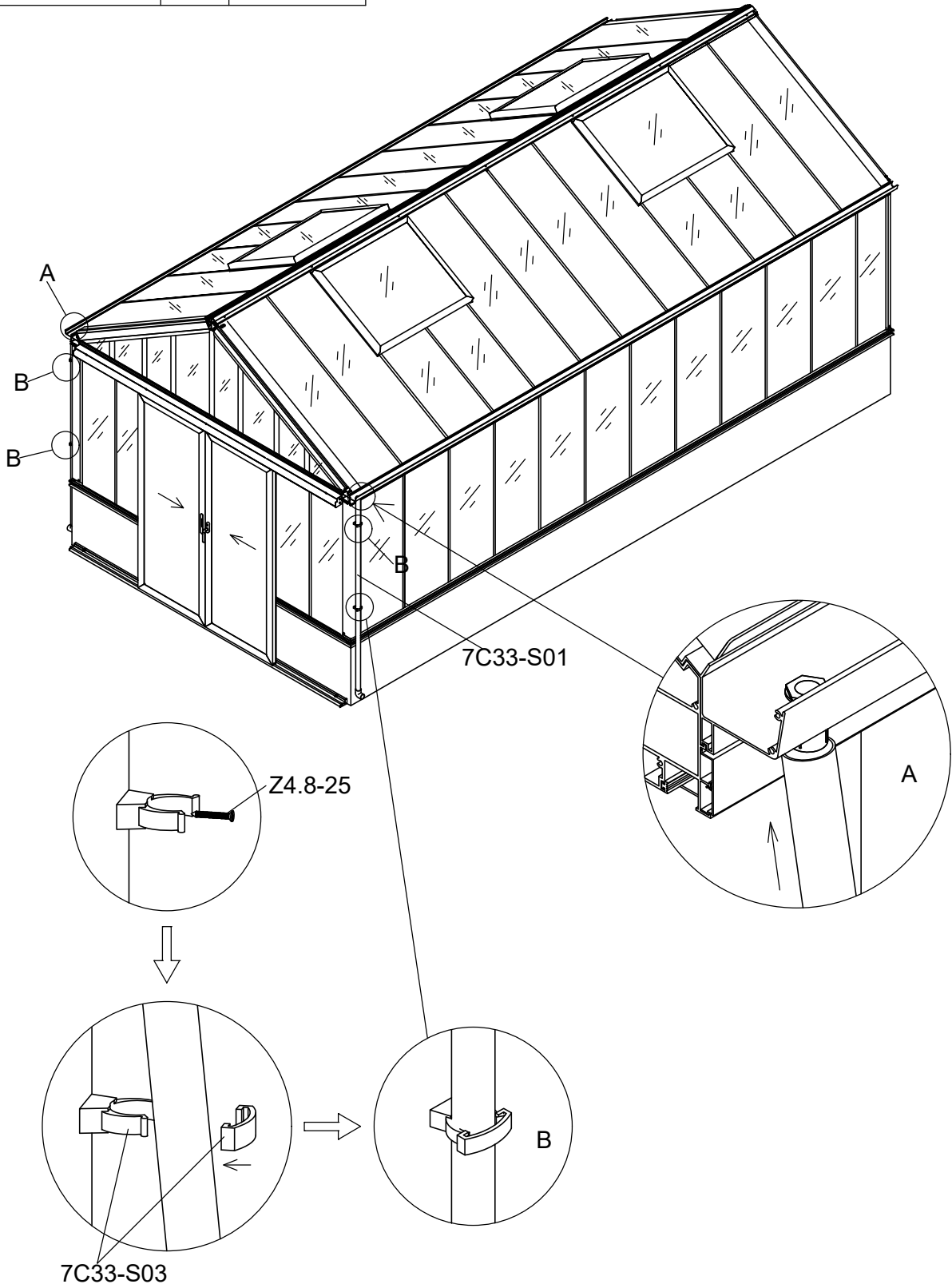

Part	NO.	QTY.	Length(MM)
	7C33-S02	2	PCS



Part	NO.	QTY.	Length(MM)
	7C33-S01	2	1980
	7C33-S03	4	PCS
	Z4.8-25	4	PCS



Part	NO.	QTY.	Length(MM)
	7B33-016	2	PCS
	7C33-005	2	PCS
	7B33-015L	2	PCS
	7B33-015R	2	PCS
	7C33-004	4	PCS
	Za4.2-13	36	PCS

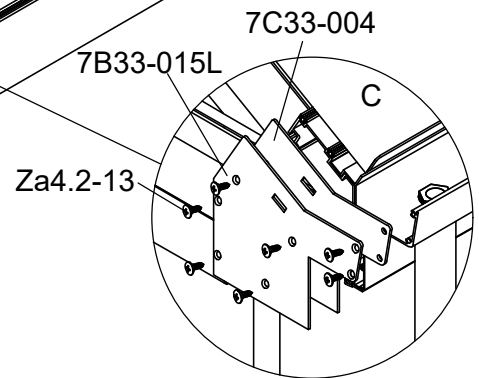
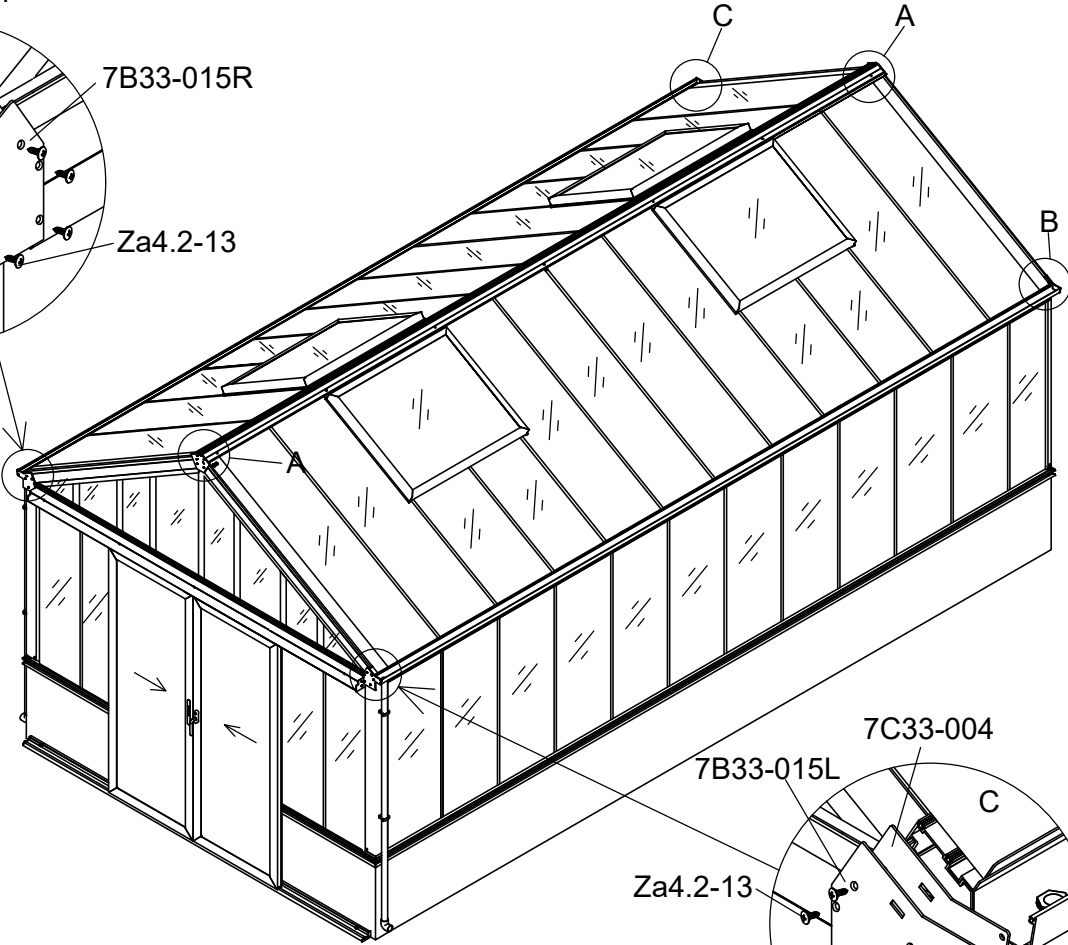
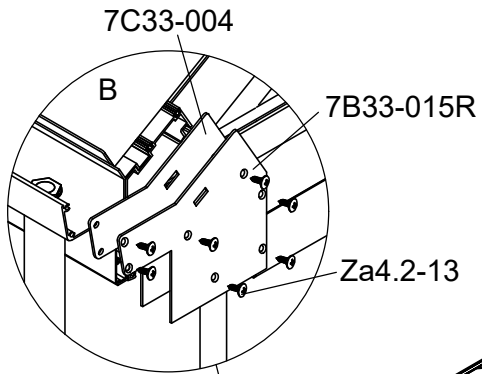
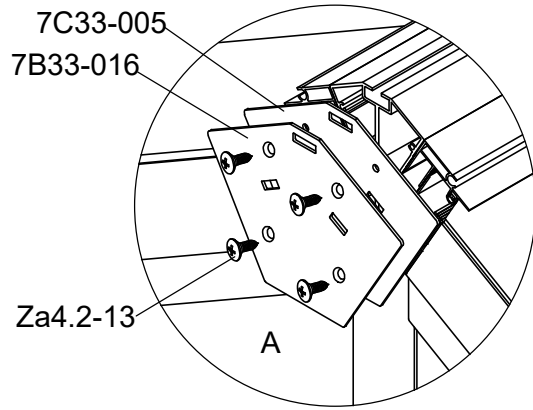

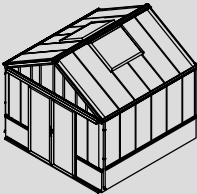
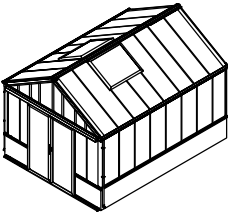
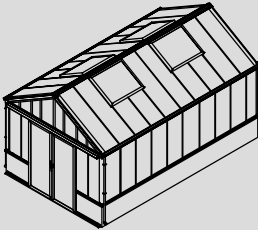
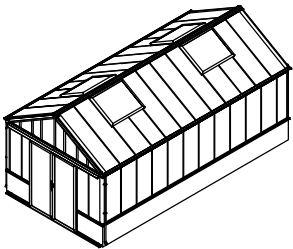
3721	3722	3723	3724
			



Part	3721		3722		3723		3724		Code
	NO.	Length(MM)	NO.	Length(MM)	NO.	Length(MM)	NO.	Length(MM)	
	41A-Y111-3	3239	41A-Y111-4	4239	41A-Y111-5	5240	41A-Y111-6	6241	A001

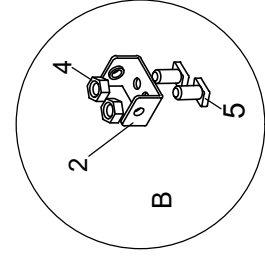
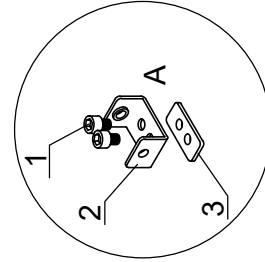
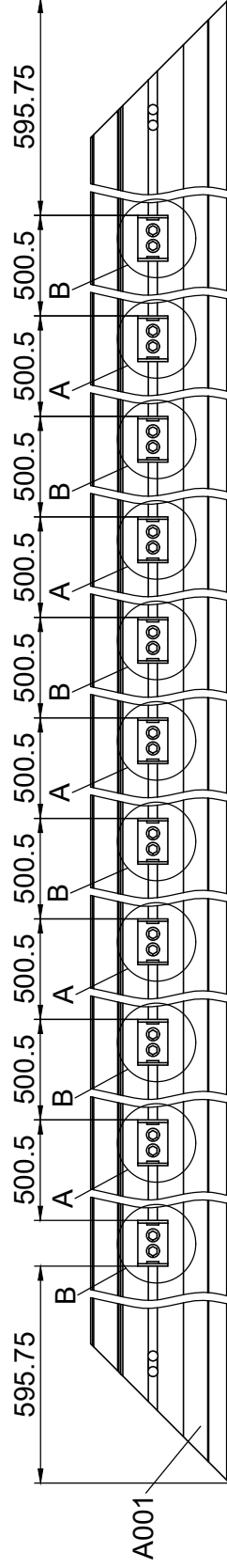

NO.	
1	M8-10
2	7B33-005
3	7B33-004
4	M8
5	Ma8-20

F1

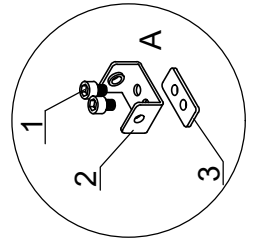
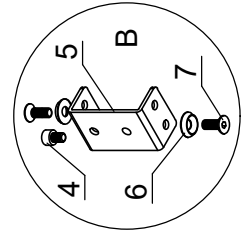
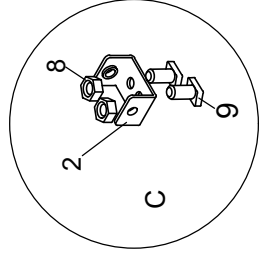
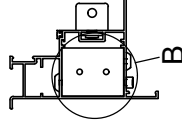
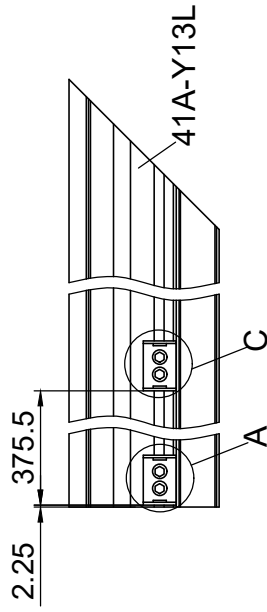
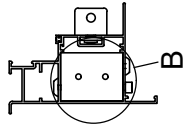
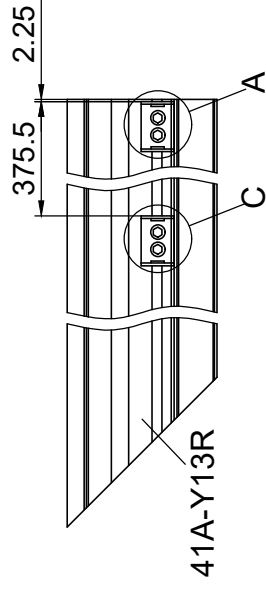
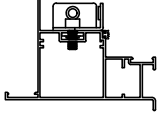
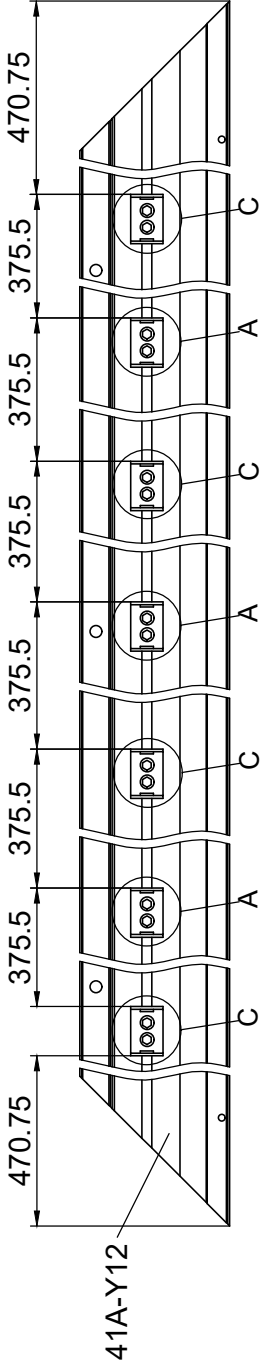

NO.	
1	M8-10
2	7B33-005
3	7B33-004
4	M6-8
5	7B33-047
6	J05
7	Si6-16
8	M8
9	Ma8-20

F2

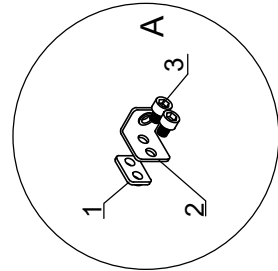
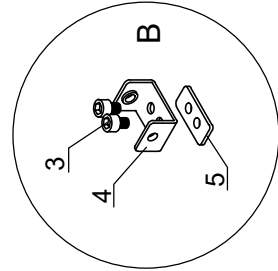
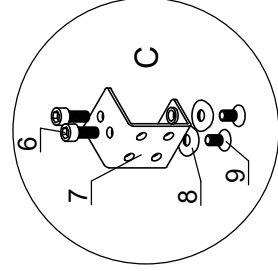
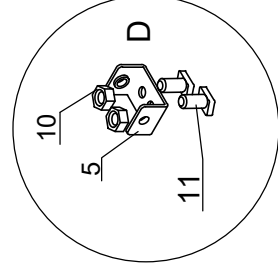
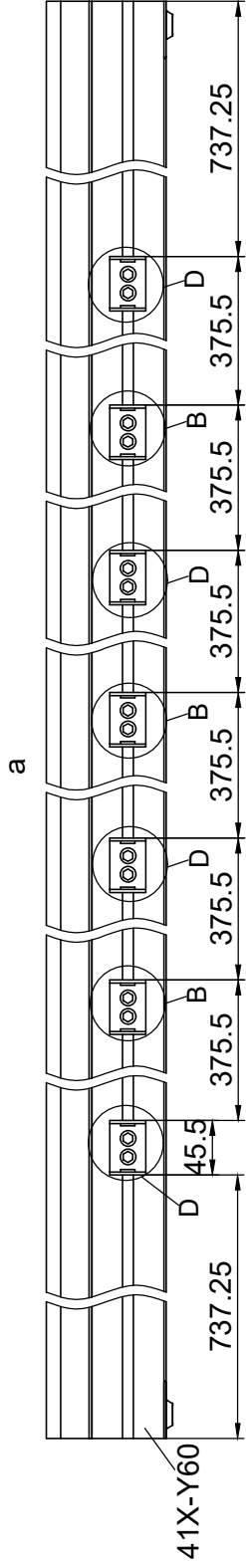
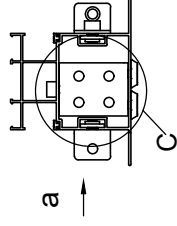
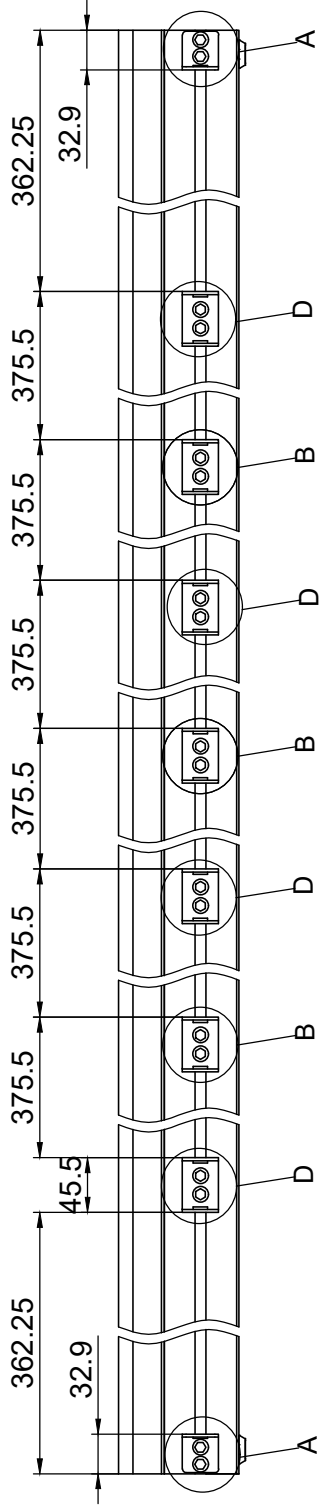

NO.	
1	7B33-006
2	7B33-007
3	M8-10
4	7B33-005
5	7B33-004
6	M8-20
7	7B33-009
8	7B33-020
9	M8-16
10	M8
11	Ma8-20

F3

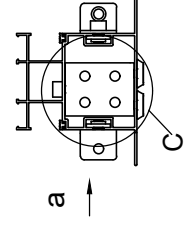
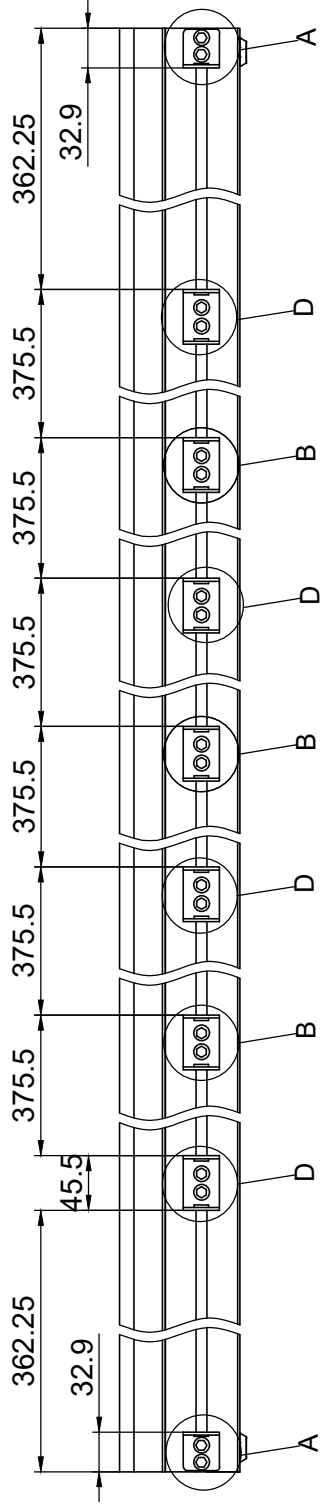

41X-Y61

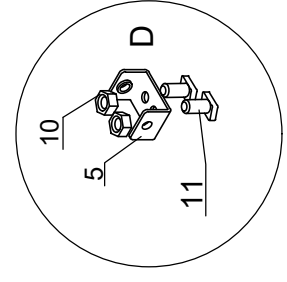
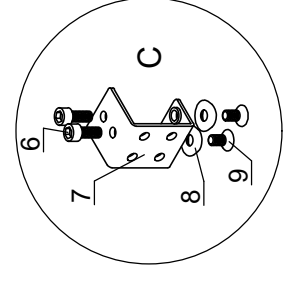
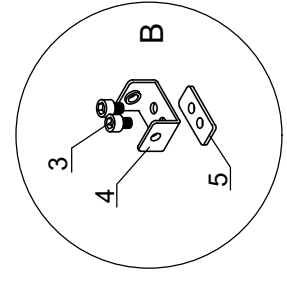
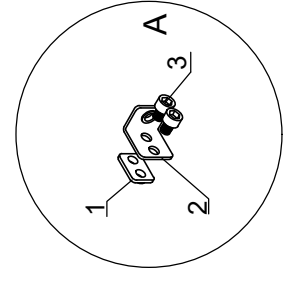
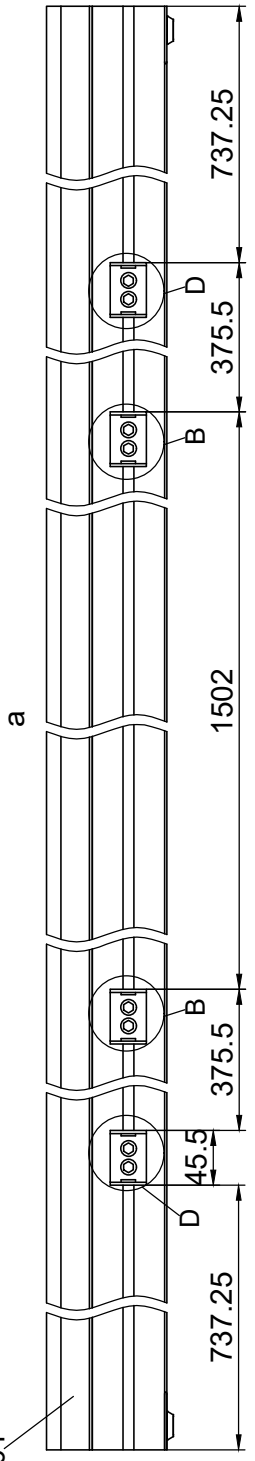

NO.	
1	7B33-006
2	7B33-007
3	M8-10
4	7B33-005
5	7B33-004
6	M8-20
7	7B33-009
8	7B33-020
9	M8-16
10	M8
11	Ma8-20

F4



Part	3721		3722		3723		3724		Code
	NO.	Length(MM)	NO.	Length(MM)	NO.	Length(MM)	NO.	Length(MM)	
 41X-Y62-3	41X-Y62-3	3228	41X-Y62-4	4228	41X-Y62-5	5229	41X-Y62-6	6230	A002

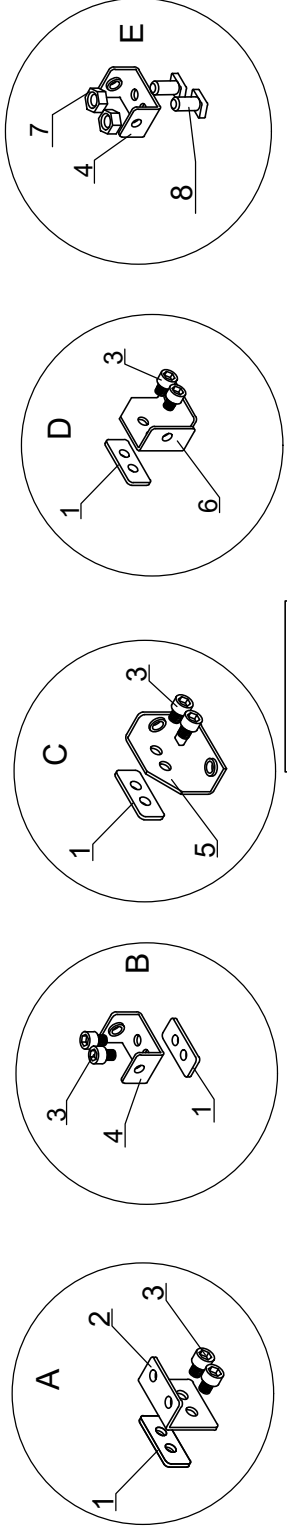
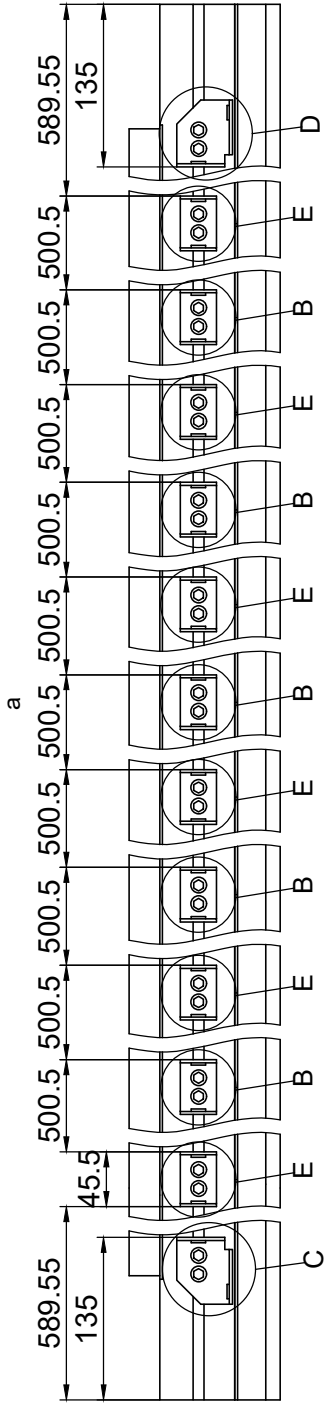
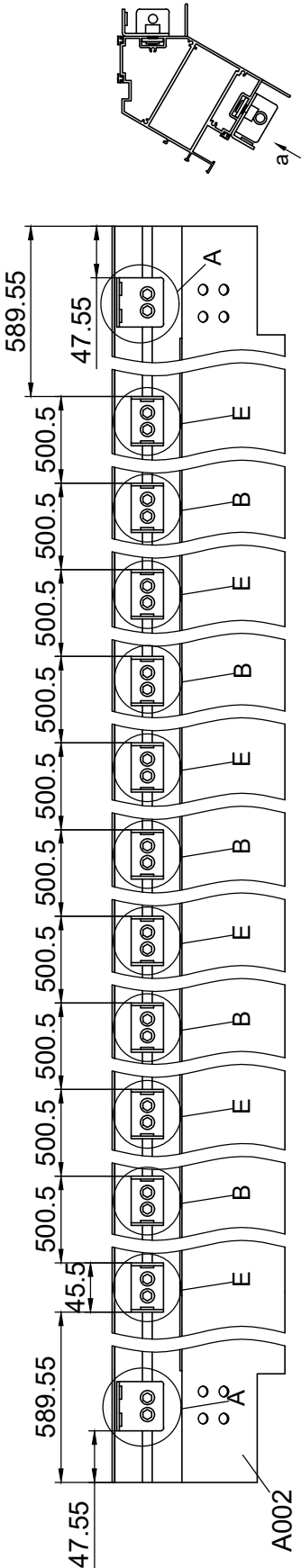

NO.	
1	7B33-004
2	7B33-010
3	M8-10
4	7B33-005
5	7B33-003
6	7B33-002
7	M8
8	Ma8-20

F5



Part	3721		3722		3723		3724		Code
	NO.	Length(MM)	NO.	Length(MM)	NO.	Length(MM)	NO.	Length(MM)	
	41X-Y63-3	3207	41X-Y63-4	4207	41X-Y63-5	5208	41X-Y63-6	6209	A003

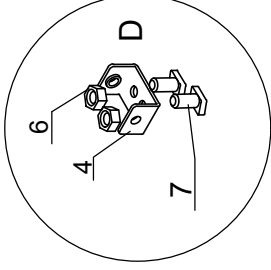
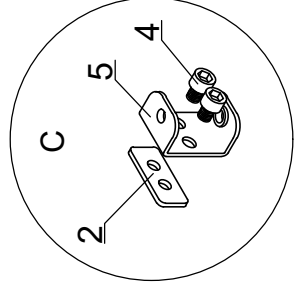
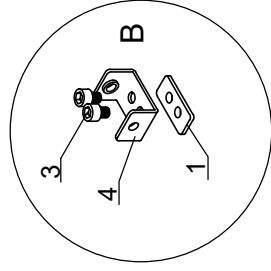
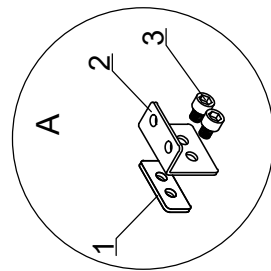
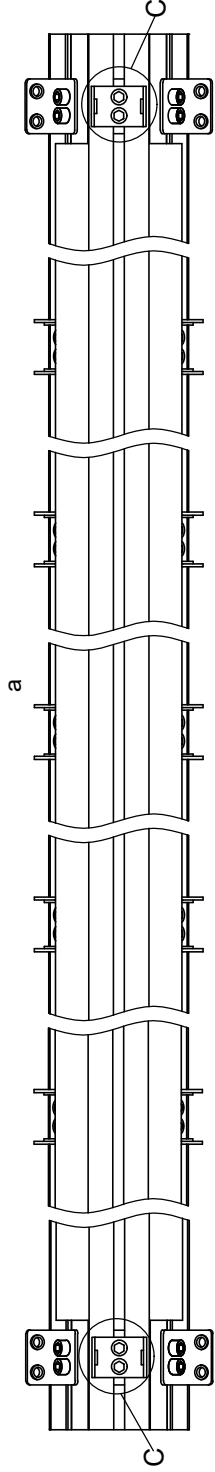
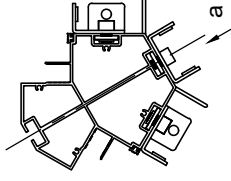
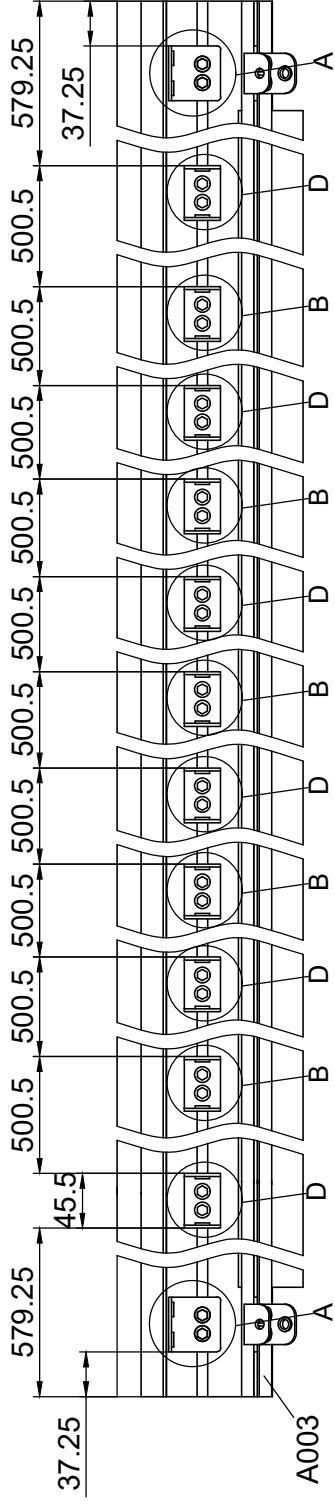

NO.	
1	7B33-004
2	7B33-010
3	M8-10
4	7B33-005
5	7B33-011
6	M8
7	Ma8-20

F6

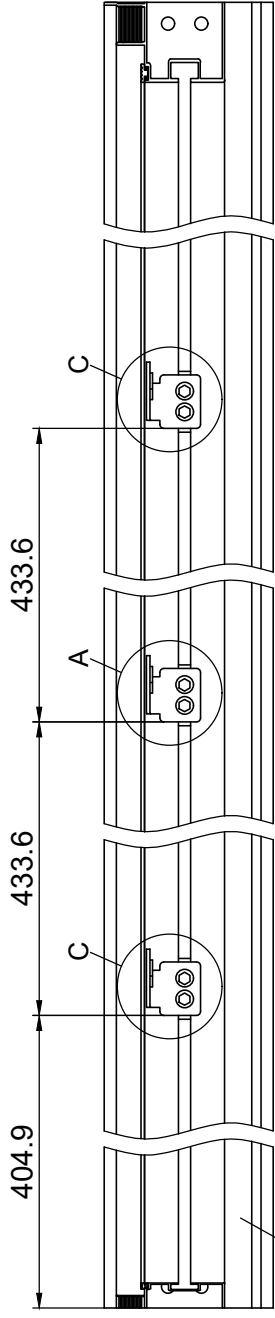

41X-Y21

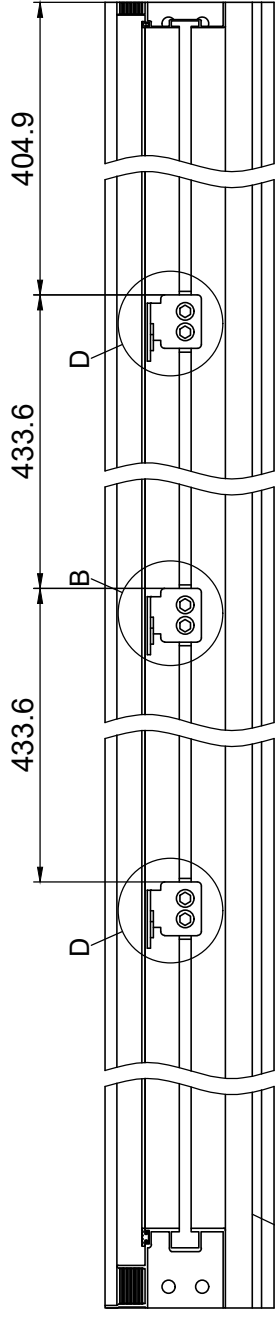

41X-Y22

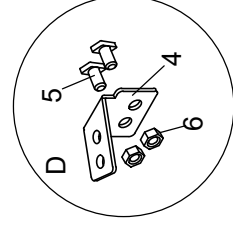
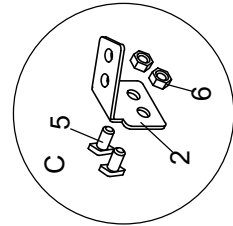
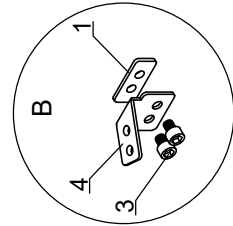
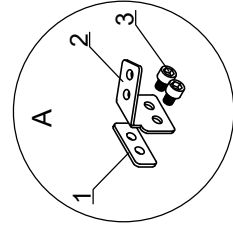
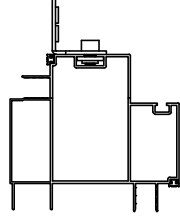
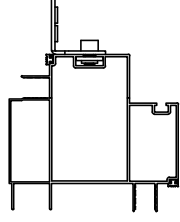

NO.	
1	7B33-004
2	7B33-013R
3	M8-10
4	7B33-013L
5	Ma8-20
6	M8

F7

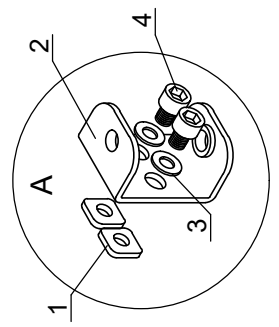
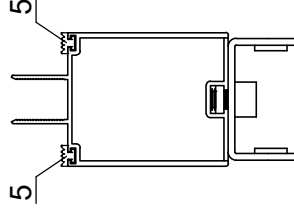
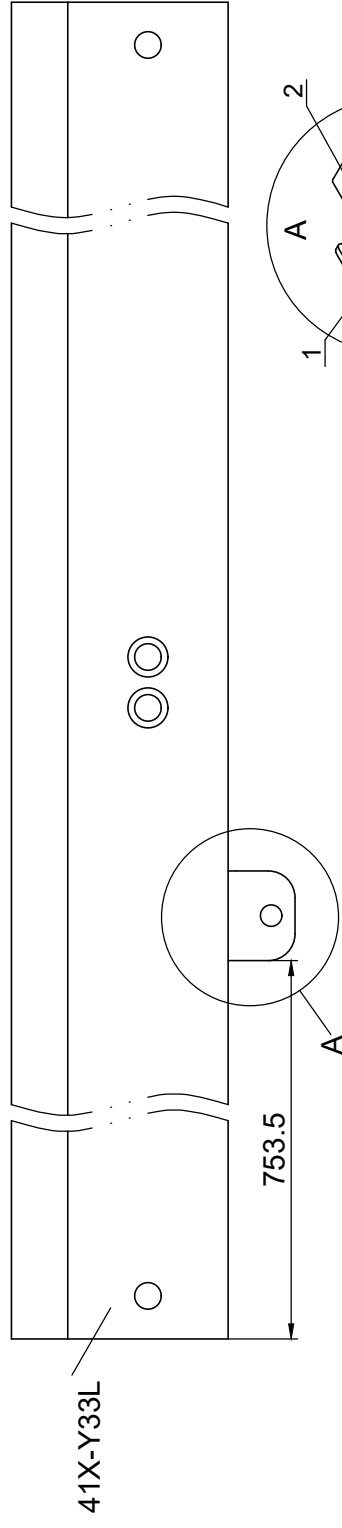
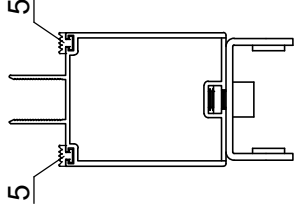
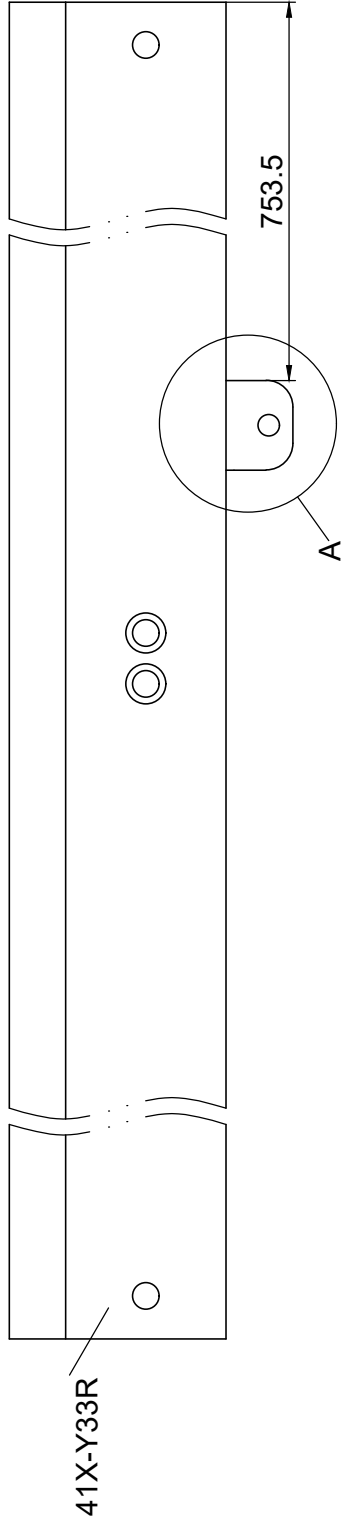
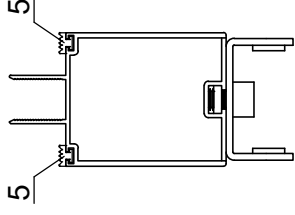
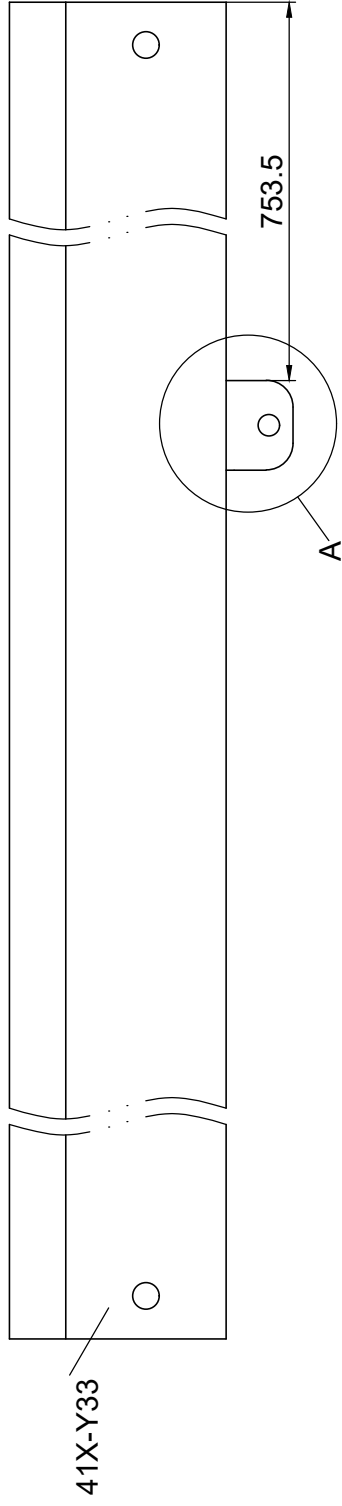

NO.	
1	MF6
2	7B33-011
3	MD6
4	M6-8
5	7C33-002

F8